



**¿PREPARADO PARA  
LA ILUMINACIÓN  
CONECTADA?  
DESPEGA CON  
LEDVANCE**



**LUMINARIAS, COMPONENTES  
ELECTRÓNICOS LEDVANCE,  
LÁMPARAS LED**

JUNIO 2020

Licencia de producto de marca OSRAM  
para lámparas en iluminación general



## ARQUITECTURA DE MARCA

EMPRESA:  **LEDVANCE**

MARCAS:  **LEDVANCE**

**OSRAM** 

PRODUCTOS: 

Luminarias LED  
y productos innovadores



Lámparas LED

## CONOZCA LEDVANCE

Somos uno de los principales proveedores de iluminación del mundo para profesionales y consumidores finales.

LEDVANCE ha surgido del negocio de iluminación de OSRAM y ofrece una amplia gama de luminarias LED para diversas áreas de aplicación, uno de los mayores portafolios de lámparas LED del sector, además de productos para la iluminación tradicional.

## SOMOS LEDVANCE

Nuestro nombre combina el origen de la compañía con una intención para el futuro.

**LED** se refiere a nuestro principal negocio y expresa la creciente importancia de los productos LED en nuestra compañía.

**ADVANCE** se refiere a nuestra ambición e intención de avanzar con la luz.

El logotipo LEDVANCE representa un pulso de luz, que ilustra el avance y el dinamismo de la empresa.

## LÁMPARAS OSRAM

Derivado a un acuerdo con OSRAM, LEDVANCE seguirá comercializando la marca OSRAM para la línea de lámparas tradicionales y LED.

Más información se puede encontrar en el sitio:  
[www.ledvance.lat](http://www.ledvance.lat)

# LEDVANCE: AVANZANDO CON LA LUZ

## ¿BUSCAS ILUMINACIÓN DE CALIDAD? CÁMBIATE A LEDVANCE.

Como un socio confiable para productos de iluminación general, luchamos contra productos de mala calidad en todo lo que hacemos. En LEDVANCE, combinamos la iluminación tradicional en general con tecnologías innovadoras, construimos relaciones duraderas con los clientes y una fuerte red de distribución de nuestros productos.

En todo el mundo somos especialistas en iluminación, en nuevas tecnologías y cambiamos para satisfacer las necesidades del mercado. Estamos presentes en más de 140 países, atendiendo demandas específicas y ayudando a clientes con nuestro equipo de expertos. Nuestra cartera de luminarias cubre todas las aplicaciones profesionales y residenciales.

Para concientizar a los consumidores sobre los productos de baja calidad disponibles en el mercado y posicionar a LEDVANCE como una marca nueva y fuerte, estamos lanzando la campaña "UNA MALA ILUMINACIÓN ARRUINA TU DÍA". La campaña hace alusión a los problemas que los productos de mala calidad ocasionan en proyectos de iluminación, y sugiere la marca LEDVANCE, que siempre ofrecerá un producto de calidad, de fácil instalación y de excelente costo-beneficio. Para atraer la atención del público, se vale de imágenes fuertes, de excelente calidad escenográfica, con leve toque de humor.



# EXPERIMENTA UNA NUEVA LUZ

**PRESENTE EN MÁS DE 140 PAÍSES.**

Europa, Estados Unidos y Canadá,  
Asia y Región Pacífica,  
América Latina, África y Medio Oriente.

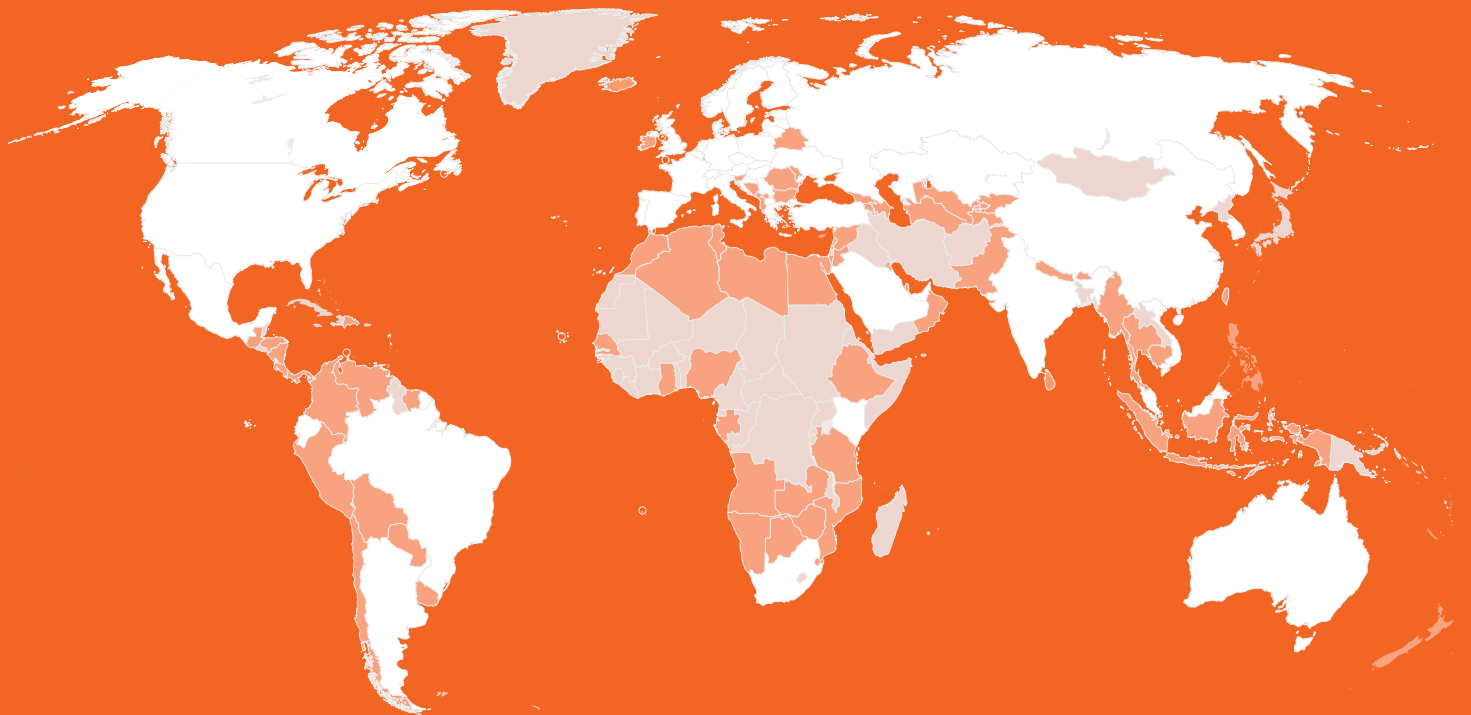



# VIDEOS DE INSTALACIÓN



Para dejar aún más clara la instalación de nuestros productos, creamos videos que muestran, además de cómo instalar, informaciones sobre los productos y sus equivalencias.



Escanea el código y echa un vistazo a nuestro canal de YouTube.

VISITA NUESTRA PÁGINA DE FACEBOOK

 [FACEBOOK.COM/LEDVANCEMEXICO](https://www.facebook.com/LEDVANCEMEXICO)

# SOLUCIONES CON BENEFICIOS INTEGRALES - NUESTRO NUEVO PORTAFOLIO DE LUMINARIAS LED

LEDVANCE ofrece una amplia gama de luminarias LED para las más diversas aplicaciones. Desarrollamos innumerables recursos en nuestros productos para facilitar el trabajo del día a día de los profesionales del área. Con nuestras luminarias Downlight Comfort podemos configurar fácilmente tres diferentes temperaturas de color, simplemente moviendo el interruptor. Nuestra cartera está orientada a satisfacer los requisitos de diversas áreas de aplicación: establecimientos, hoteles, centros comerciales, hospitales, industrias y parques.

La línea de luminarias LEDVANCE es de alto rendimiento, cualquier lanzamiento siempre tendrá el objetivo de proporcionar soluciones inteligentes de iluminación fáciles de instalar. Estamos preparados para seguir desarrollando productos de alta demanda y generando nuevas oportunidades en el mercado.

#### **Tres principios fundamentales:**

Instalaciones sencillas, excelente costo-beneficio y ahorro de energía.

En concreto, nuestro portafolio de luminarias LED realmente es de otro nivel.

**Sin duda éstas son buenas noticias para usted, malas noticias para la mala iluminación.**



# ÍNDICE

## LUMINARIAS LEDVANCE

### RESIDENCIAL

SLIM PLAFON	11
FOCOLUM	12
INSERT SQUARE	13
INSERT ROUND	14
LIVIN	15



### PROFESIONAL / COMERCIAL

PANEL	18
SPOTLIGHT	19
DOWNLIGHT	20
DOWNLIGHT PARA BOTE INTEGRAL	21
DOWNLIGHT COMFORT	22
LINEAR	23
LINEAR PENDANT	24
PENDULUM	25
TRACKLIGHT	26
MULTISPOT	30



### INDUSTRIAL

HIGHBAY 220 V	33
HIGHBAY 135 lm/W	34
HIGHBAY RECESSED	35
FLOODLIGHT HIGH WATTAGE 50 000 h	36
FLOODLIGHT HIGH WATTAGE 30 000 h	37
FLOODLIGHT ASYMMETRICAL	38
FLOODLIGHT HIGH POWER	39
DAMP-PROOF HOUSING	41
DAMP-PROOF LED	42
DAMP-PROOF SENSOR	43
WALL PACK	44



### EXTERIOR

SPIKE	47
WALL LIGHT	48
ENDURA	49
BOLLARD	50
FLOODLIGHT BLANCO Y NEGRO	51
FLOODLIGHT SENSOR	52
WALL WASHER	54
AREALIGHT	55



### ALUMBRADO PÚBLICO

SKY	58
-----	----



---

# RESIDENCIAL









# LEDVANCE® SLIM PLAFON

Luminaria de techo para sobreponer o empotrar tipo plafón, con diseño compacto y marco reducido que emite una luz homogénea a través de su difusor. Disponible en versiones redondo y cuadrado en dos temperaturas de color: Luz de Día (6500 K) y Luz Cálida (3000 K). De fácil y rápida instalación.



It is a ceiling luminaire to embed, recessed lighting fixture type. It has an ultrafine design and reduced frame, which emits homogeneous light through its diffuser. Available in round and square versions, at two color temperatures: Day Light (6500 K) and Warm Light (3000 K). Quick and easy to install.

**HASTA 50% DE ECONOMÍA**  
SAVES UP TO SAVINGS

**3 AÑOS DE GARANTÍA**  
YEAR WARRANTY

**100 - 240 V~**

**IP 20**

**DISEÑO COMPACTO DE LUZ UNIFORME MARCO REDUCIDO**  
COMPACT DESIGN AND REDUCED FRAME

**DISTRIBUCIÓN DE LUZ UNIFORME**  
UNIFORM DISTRIBUTION OF LIGHT

**2 X 1 APLICACION DUAL**  
2 X 1 DUAL APPLICATION

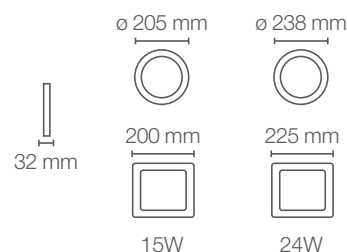

## APLICACIONES / APPLICATIONS

Salas  
Living rooms

Recámaras  
Rooms

Oficinas  
Offices

Cocinas  
Kitchens

Baños  
Bathrooms

Cuartos de Lavado  
Laundry rooms

Cocheras  
Garages

Pasillos  
Corridors

Despensas  
Pantries

Código Sku	Potencia Power (W)	Equivalencia Equivalence CFL (W)	Flujo Luminoso Luminous Flux (lm)	Ángulo de Apertura Opening Angle	Temp. de Color Color Temp. (K)	Vida Útil Life (h)	IRC CRI	Dimensiones Dimensions (mm)	Color de Producto Product Color	Unidades por Caja Units per box
86490	15	2 x 15	1 125	120°	3000	25 000	> 80	○ Ø 205 x 32	Blanco	10
86491	15	2 x 15	1 125	120°	3000	25 000	> 80	□ 200 x 200 x 32	Blanco	10
86492	15	2 x 15	1 125	120°	6500	25 000	> 80	○ Ø 205 x 32	Blanco	10
86493	15	2 x 15	1 125	120°	6500	25 000	> 80	□ 200 x 200 x 32	Blanco	10
86494	24	2 x 23	1 800	120°	3000	25 000	> 80	○ Ø 238 x 32	Blanco	10
86495	24	2 x 23	1 800	120°	3000	25 000	> 80	□ 225 x 225 x 32	Blanco	10
86496	24	2 x 23	1 800	120°	6500	25 000	> 80	○ Ø 238 x 32	Blanco	10
86497	24	2 x 23	1 800	120°	6500	25 000	> 80	□ 225 x 225 x 32	Blanco	10

\* En sustitución de lámparas CFL compactas / In the replacement of compact CFL lamps.

**RA**  
Contenido relacionado con este producto en Realidad Aumentada



# LEDVANCE® FOCOLUM

Luminaria para empotrar tipo spot. Disponible en versión redondo y cuadrado, en temperatura Luz Cálida (3000 K). De fácil y rápida instalación.

Luminaire to embed, spot type. Available in round and square versions, in Warm Light temperature: (3000 K). Quick and easy to install.



- HASTA 90% DE ECONOMÍA**

SAVES UP TO SAVINGS
- 3 AÑOS DE GARANTÍA**

YEAR WARRANTY
- 100 – 240 V~**
- IP 20**
- FOCO AJUSTABLE 180°**

LAMP ADJUSTABLE 180°
- FLUJO LUMINOSO IDEAL PARA APLICACIONES RESIDENCIALES**

LUMINOUS FLUX IDEAL FOR RESIDENTIAL APPLICATIONS

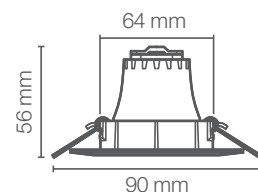

## APLICACIONES / APPLICATIONS



Código Sku	Potencia Power (W)	Equivalencia Equivalence Halógeno (W)	Flujo Luminoso Luminous Flux (lm)	Ángulo de Apertura Opening Angle	Temp. de Color Color Temp. (K)	Vida Útil Life (h)	IRC CRI	Dimensiones Dimensions (mm)	Color de Producto Product Color	Unidades por Caja Units per box
86434	3.3	35	270	36°	● 3 000	25 000	> 80	90 x 90 x 56	Blanco	6
86435	3.3	35	270	36°	● 3 000	25 000	> 80	∅ 90 x 56	Blanco	6
86436	4.5	50	450	42°	● 3 000	25 000	> 80	90 x 90 x 56	Blanco	6
86437	4.5	50	450	42°	● 3 000	25 000	> 80	∅ 90 x 56	Blanco	6

\* En sustitución de lámparas halógenas convencionales / In replacement of conventional halogen lamps.

  
 Contenido relacionado con este producto en Realidad Aumentada



# LEDVANCE® INSERT SQUARE

Luminaria de techo para empotrar con diseño ultra delgado y con una distribución de luz homogénea. Equipada con LED de alta potencia. Disponible en versión cuadrado con tres temperaturas de color: Luz Cálida (3000 K), Blanco Frío (4000 K) y Luz de Día (6500 K). Instalación fácil y rápida. No es necesario el uso de lámpara complementarias.

Indoor lighting with ultra slim design and homogeneous distribution light. Equipped with high power led. Available in three versions: Warm Light (3000 K), Cool Light (4000 K) and Day Light (6500 K). Easy and fast installing. No need additional lamps.

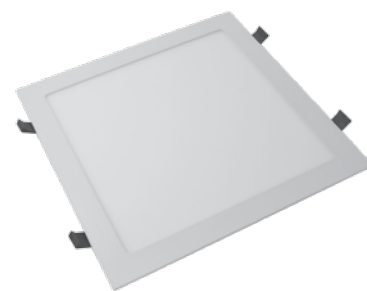

 <b>HASTA 50% DE ECONOMÍA</b> <small>SAVES UP TO SAVINGS</small>	 <b>3 AÑOS DE GARANTÍA</b> <small>YEAR WARRANTY</small>	 <b>100 – 240 V~</b>	 <b>IP20</b>	 <b>DISTRIBUCIÓN DE LUZ UNIFORME</b> <small>UNIFORM DISTRIBUTION OF LIGHT</small>	 <b>DISEÑO ULTRA DELGADO</b> <small>ULTRA FINE DESIGN</small>	 <b>23 mm</b>	 <b>172 mm</b> <b>12W</b>	 <b>225 mm</b> <b>18W</b>	 <b>300 mm</b> <b>24W</b>
--	---	-------------------------	-----------------	---	---	------------------	---------------------------------	---------------------------------	---------------------------------

## APLICACIONES / APPLICATIONS



Código Sku	Potencia Power (W)	Equivalencia Equivalence CFL (W)	Flujo Luminoso Luminous Flux (lm)	Ángulo de Apertura Opening Angle	Temp. de Color Color Temp. (K)	Vida Útil Life (h)	IRC CRI	Dimensiones Dimensions (mm)	Color de Producto Product Color	Unidades por Caja Units per box
86442	12	2 x 13	950	120°	● 3000	25 000	>80	172 x 172 x 23	Blanco	10
86443	12	2 x 13	950	120°	○ 4000	25 000	>80	172 x 172 x 23	Blanco	10
86444	12	2 x 13	950	120°	● 6500	25 000	>80	172 x 172 x 23	Blanco	10
86448	18	2 x 15	1 500	120°	● 3000	25 000	>80	225 x 225 x 23	Blanco	10
86449	18	2 x 15	1 500	120°	○ 4000	25 000	>80	225 x 225 x 23	Blanco	10
86450	18	2 x 15	1 500	120°	● 6500	25 000	>80	225 x 225 x 23	Blanco	10
86454	24	2 x 23	2 200	120°	● 3000	25 000	>80	300 x 300 x 23	Blanco	10
86455	24	2 x 23	2 200	120°	○ 4000	25 000	>80	300 x 300 x 23	Blanco	10
86456	24	2 x 23	2 200	120°	● 6500	25 000	>80	300 x 300 x 23	Blanco	10

\* En sustitución de lámparas CFL compactas / In the replacement of compact CFL lamps.



# LEDVANCE® INSERT ROUND

Luminaria de techo para empotrar con diseño ultra delgado y con una distribución de luz homogénea. Equipada con LED de alta potencia. Disponible en versión redondo con tres temperaturas de color: Luz Cálida (3000 K), Blanco Frío (4000 K) y Luz de Día (6500 K). Instalación fácil y rápida. No es necesario el uso de lámparas complementarias.

Indoor lighting with ultra slim design and homogeneous distribution light. Equipped with high power led. Available in three versions: Warm Light (3000 K), Cool Light (4000 K) and Day Light (6 500 K). Easy and fast installing. No need additional lamps.



**HASTA 50% DE ECONOMÍA**

SAVES UP TO SAVINGS

**3 AÑOS DE GARANTÍA**

YEAR WARRANTY

**100 – 240 V~**

**IP20**

**DISTRIBUCIÓN DE LUZ UNIFORME**

UNIFORM DISTRIBUTION OF LIGHT

**DISEÑO ULTRA DELGADO**

ULTRA FINE DESIGN

23 mm

∅ 170 mm

12W

∅ 225 mm

18W

∅ 300 mm

24W

## APLICACIONES / APPLICATIONS



Código Sku	Potencia Power (W)	Equivalencia Equivalence CFL (W)	Flujo Luminoso Luminous Flux (lm)	Ángulo de Apertura Opening Angle	Temp. de Color Color Temp. (K)	Vida Útil Life (h)	IRC CRI	Dimensiones Dimensions (mm)	Color de Producto Product Color	Unidades por Caja Units per box
86445	12	2 x 13	950	120°	3000	25 000	>80	∅ 170 x 23	Blanco	10
86446	12	2 x 13	950	120°	4000	25 000	>80	∅ 170 x 23	Blanco	10
86447	12	2 x 13	950	120°	6500	25 000	>80	∅ 170 x 23	Blanco	10
86451	18	2 x 15	1 500	120°	3000	25 000	>80	∅ 225 x 23	Blanco	10
86452	18	2 x 15	1 500	120°	4000	25 000	>80	∅ 225 x 23	Blanco	10
86453	18	2 x 15	1 500	120°	6500	25 000	>80	∅ 225 x 23	Blanco	10
86457	24	2 x 23	2 200	120°	3000	25 000	>80	∅ 300 x 23	Blanco	10
86458	24	2 x 23	2 200	120°	4000	25 000	>80	∅ 300 x 23	Blanco	10
86459	24	2 x 23	2 200	120°	6500	25 000	>80	∅ 300 x 23	Blanco	10

\* En sustitución de lámparas CFL compactas / In the replacement of compact CFL lamps.







# LEDVANCE® LIVIN

Luminaria de techo para sobreponer con diseño lineal y moderno. Está equipada con LED de alta potencia con luz blanca, que ilumina el ambiente de manera uniforme. Instalación fácil y rápida. No es necesario el uso de lámparas complementarias. Disponible en versiones corta y larga.

Indoor lighting with a linear and modern design. Equipped with high power led with day light, it lights up uniformly the environment. Easy and fast installing. No need additional lamps.

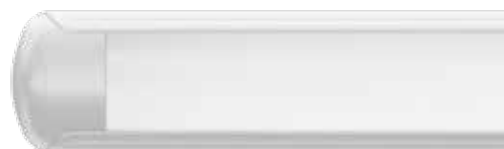

**HASTA 50% DE ECONOMÍA**

SAVES UP TO SAVINGS

**3 AÑOS DE GARANTÍA**

YEAR WARRANTY

**100 - 240 V~**

**IP 20**

**DISEÑO ULTRA DELGADO**

ULTRA FINE DESIGN

**ALTA EFICIENCIA**

HIGH EFFICIENCY

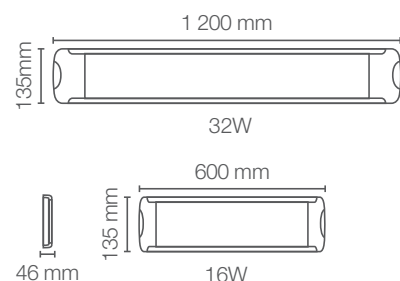

## APLICACIONES / APPLICATIONS

Oficinas  
Offices

Cocinas  
Kitchens

Cuartos de Lavado  
Laundry Rooms

Cocheras  
Garages

Pasillos  
Corridors

Despensas  
Pantries

Código Sku	Potencia Power (W)	Equivalencia Fluor. (W)	Flujo Luminoso Luminous Flux (lm)	Ángulo de Apertura Opening Angle	Temp. de Color Color Temp. (K)	IRC CRI	Vida Útil Life (h)	Dimensiones Dimensions (mm)	Color de Producto Product Color	Unidades por Caja Units per box
83194	16	2 x 17 T8	1 400	110°	5000	>80	30 000	600 x 135 x46	Blanco	10
83195	32	2 x 32 T8	3 000	110°	5000	>80	30 000	1200 x 135 x46	Blanco	8



Contenido relacionado con este producto en Realidad Aumentada

\* En sustitución de lámparas fluorescentes tubulares / In the replacement of tubular fluorescent lamps.





---

# PROFESIONAL / COMERCIAL



# LEDVANCE® PANEL

Luminaria de techo para empotrar tipo panel, ideal para iluminación de oficinas y ambientes corporativos. Diseño moderno y funcional que ayuda a distribuir la luz de manera homogénea, acabado en aluminio blanco mate de fácil instalación. Disponible en versión cuadrado y rectangular.

Panel type ceiling luminaire to embed. It is ideal to light up offices and corporate environments. Easy to install. Modern and functional design. Homogeneous light distribution. Available in square and rectangular versions.

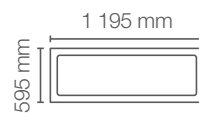
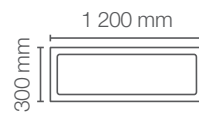
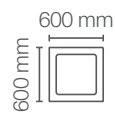
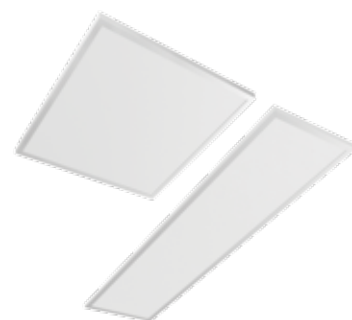

## APLICACIONES / APPLICATIONS



Código Sku	Potencia Power (W)	Equivalencia Equivalence Fluor. (W)	Flujo Luminoso Luminous Flux (lm)	Ángulo de Apertura Opening Angle	Tensión Tension (V~)	Temp. de Color Color Temp. (K)	Vida Útil Life (h)	IRC CRI	Dimensiones Dimensions (mm)	Color de Producto Product Color	Unidades por Caja Units per box
86579	40	3 x 14 T5 o 2 x 32 T8	4000	120°	100-277	○ 4000	50 000	>80	600 x 600 x 8.5	Blanco	5
86580	40	3 x 14 T5 o 2 x 32 T8	4000	120°	100-277	● 6500	50 000	>80	600 x 600 x 8.5	Blanco	5
86581	40	2 x 28 T5 o 2 x 32 T8	4000	120°	100-277	○ 4000	50 000	>80	1200 X 300 X 8.5	Blanco	5
86582	40	2 x 28 T5 o 2 x 32 T8	4000	120°	100-277	● 6500	50 000	>80	1200 X 300 X 8.5	Blanco	5
85337	60	3 x 28 T5 o 2 x 32 T8	6000	120°	100-240	○ 4000	30 000	>80	1195 x 595 x 10.5	Blanco	3
85336	60	3 x 28 T5 o 2 x 32 T8	6000	120°	100-240	● 6500	30 000	>80	1195 x 595 x 10.5	Blanco	3



\* Se venden por separado

Accesorios\*  
Accessories\*

86806	Marco para sobreponer Panel 600 x 600 x 8.5
86807	Marco para sobreponer Panel 1200 x 300 x 8.5
80553	Kit de Suspensión
86809	Kit de Sujeción

\* En sustitución de lámparas fluorescentes tubulares / In replacement of tubular fluorescent lamps.





# LEDVANCE® SPOTLIGHT

Luminaria de techo para empotrar tipo spot, utilizada para destacar objetos o ambientes. Lámpara ajustable con recubrimiento antirreflejante, ideal para iluminación decorativa en establecimientos, oficinas, centros comerciales y hoteles. Acabado en blanco mate.

Ceiling luminaire to embed, spot type. It is used to highlight objects or environments. Adjustable lamp with anti-glare coating. It is ideal for decorative lighting in shops, offices, shopping centers. In matt white.



**HASTA 90% DE ECONOMÍA**  
SAVES UP TO SAVINGS

**3 AÑOS DE GARANTÍA**  
YEAR WARRANTY

**100 - 240 V~**

**IP 20**

**RECUBRIMIENTO ANTIRREFLEJANTE**  
ANTI-GLARE COATING

**FOCO AJUSTABLE**  
ADJUSTABLE LAMP

**LED COB**  
LED COB

**DRIVER PLUG & PLAY**

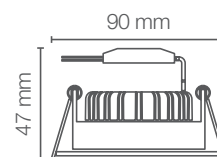

## APLICACIONES / APPLICATIONS

- Oficinas / Offices
- Establecimientos / Shops
- Bar/ Restaurants / Restaurants
- Hoteles / Hotels
- Museos/Galerías / Museums/Galleries

Código Sku	Potencia Power (W)	Equivalencia Equivalence Halógena (W)	Flujo Luminoso Luminous Flux (lm)	Ángulo de Apertura Opening Angle	Temp. de Color Color Temp. (K)	IRC CRI	Vida Útil Life (h)	Dimensiones Dimensions (mm)	Color de Producto Product Color	Unidades por Caja Units per box
82876	10	75	800	36°	3000	>80	30 000	Ø 90 x 47	Blanco	20
85271	10	75	800	36°	6500	>80	30 000	Ø 90 x 47	Blanco	20

\* En sustitución de lámparas halógenas convencionales / In replacement of conventional halogen lamps.

**RA**  
Contenido relacionado con este producto en Realidad Aumentada



# LEDVANCE® DOWNLIGHT

Luminaria de techo para empotrar ideal para ambientes profesionales.  
 Acabado en aluminio blanco mate.  
 Disponible en temperaturas de color: Luz Cálida (3000 K), Blanco Frío (4000 K)  
 y Luz de Día (6500 K).

Ceiling luminaire to embed. It is ideal for professional environments. Available in color  
 temperatures Warm Light (3000 K), Cool Light (4000 K) and Day Light (6500 K).  
 Finished in matt white aluminum.



**HASTA  
60%  
DE  
ECONOMÍA**  
SAVES UP TO  
SAVINGS

**3**  
AÑOS DE  
GARANTÍA  
YEAR  
WARRANTY

**100 - 277 V~**

**IP44**

**DIFUSOR DE  
ALTA CALIDAD**  
HIGH QUALITY  
DIFFUSER

**DRIVER  
PLUG & PLAY**

**CLIPS  
CUBIERTOS DE  
GOMA**  
RUBBER  
COVERED CLIPS

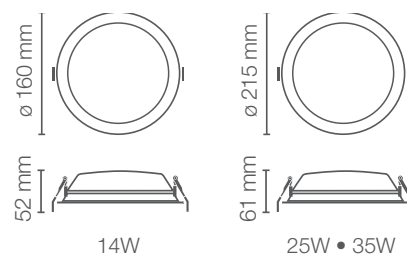

## APLICACIONES / APPLICATIONS

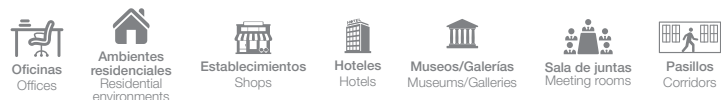

Código Sku	Potencia Power (W)	Equivalencia Equivalence CFL (W)	Flujo Luminoso Luminous Flux (lm)	Ángulo de Apertura Opening Angle	Temp. de Color Color Temp. (K)	IRC CRI	Vida Útil Life (h)	Dimensiones Dimensions (mm)	Color de Producto Product Color	Unidades por Caja Units per box
86707	14	2 x 18	1 200	95°	● 3 000	>80	30 000	Ø 160 x 52	Blanco	8
80503	14	2 x 18	1 200	95°	○ 4 000	>80	30 000	Ø 160 x 52	Blanco	8
86708	14	2 x 18	1 200	95°	● 6 500	>80	30 000	Ø 160 x 52	Blanco	8
86709	25	2 x 32	2 200	100°	● 3 000	>80	30 000	Ø 215 x 61	Blanco	8
80428	25	2 x 32	2 200	100°	○ 4 000	>80	30 000	Ø 215 x 61	Blanco	8
86710	25	2 x 32	2 200	100°	● 6 500	>80	30 000	Ø 215 x 61	Blanco	8
86711	35	2 x 42	3 300	100°	○ 4 000	>80	30 000	Ø 215 x 61	Blanco	8

\* En sustitución de lámparas CFL compactas / In the replacement of compact CFL lamps.



Contenido relacionado con este producto  
 en Realidad Aumentada





# LEDVANCE® DOWNLIGHT PARA BOTE INTEGRAL

Luminaria con controlador integrado para su aplicación en bote integral de 8 cm y 12 cm. Con construcción en aluminio y difusor en policarbonato lo que permite una distribución uniforme de luz. Disponible en 3 temperaturas 3 000 K / 4 000 K / 6 500 K y además una versión atenuable.

Luminaire with integrated controller for application in 8 cm and 12 cm integral boat. With construction in aluminum and diffuser in polycarbonate that allows a uniform distribution of light. Available in 3 temperatures 3 000 K / 4 000 K / 6 500 K and also an dimmable version.



- HASTA  
**60%**  
DE  
ECONOMÍA

SAVES UP TO SAVINGS
- 3**

AÑOS DE GARANTÍA

YEAR WARRANTY
- 0 100

ATENUABLE A FASE

DIMMING
- IP 20**
- 100 – 277 V~

NON DIMMABLE
- 120 V~

DIMMABLE

- Ambientes residenciales  
Residential environments
- Establecimientos  
Shops
- Oficinas  
Offices
- Pasillos  
Corridors
- Sala de juntas  
Meeting rooms

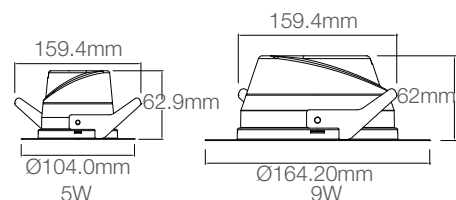

Código Sku	Potencia Power (W)	Equivalencia Equivalence CFL (W)	Flujo Luminoso Luminous Flux (lm)	Ángulo de Apertura Opening Angle	Temp. de Color Color Temp. (K)	Vida Útil Life (h)	IRC CRI	Dimensiones Dimensions (mm)	Color de Producto Product Color	Unidades por Caja Units per box
80302	5	1 x 13	400	110°	● 3000	30 000	>80	Ø104x629	Blanco	12
80303	5	1 x 13	400	110°	○ 4000	30 000	>80	Ø104x629	Blanco	12
80304	5	1 x 13	400	110°	● 6500	30 000	>80	Ø104x629	Blanco	12
80305	9	2 x 13	720	110°	● 3000	30 000	>80	Ø164.2x620	Blanco	12
80306	9	2 x 13	720	110°	○ 4000	30 000	>80	Ø164.2x620	Blanco	12
80307	9	2 x 13	720	110°	● 6500	30 000	>80	Ø164.2x620	Blanco	12
80308	5	1 x 13	400	110°	● 3000	30 000	>80	Ø104x629	Blanco	12
80309	5	1 x 13	400	110°	○ 4000	30 000	>80	Ø104x629	Blanco	12
80310	5	1 x 13	400	110°	● 6500	30 000	>80	Ø104x629	Blanco	12
80311	9	2 x 13	720	110°	● 3000	30 000	>80	Ø164.2x620	Blanco	12
80312	9	2 x 13	720	110°	○ 4000	30 000	>80	Ø164.2x620	Blanco	12
80313	9	2 x 13	720	110°	● 6500	30 000	>80	Ø164.2x620	Blanco	12

\* En sustitución de lámparas CFL compactas / In the replacement of compact CFL lamps.



# LEDVANCE® DOWNLIGHT COMFORT

Luminaria de techo para empotrar con 3 temperaturas de color en el mismo producto: 3000 K, 4000 K y 5700 K. Dponible en dos potencias con recubrimiento antideslumbrante (UGR <22).

Ceiling luminaire to embed with 3 color temperatures in the same product: 3000 K, 4000 K and 5700 K. Available in two versions with anti-glare coating (UGR <22).

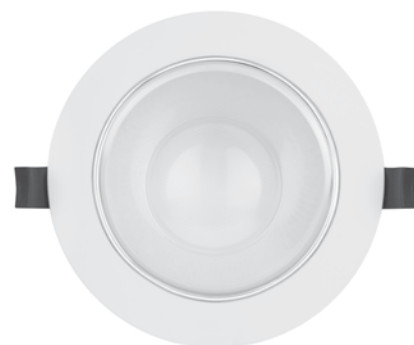

**HASTA 50% DE ECONOMÍA**  
SAVES UP TO SAVINGS

**5 AÑOS DE GARANTÍA**  
YEAR WARRANTY

**100 - 277 V~**

**IP54**

**DIFUSOR DE ALTA CALIDAD**  
HIGH QUALITY DIFFUSER

**CLIPS CUBIERTOS DE GOMA**  
RUBBER COVERED CLIPS

**RECUBRIMIENTO ANTIDESLUMBRANTE**  
ANTI-GLARE COATING

**3 TEMPERATURAS EN 1**  
TEMPERATURES IN 1

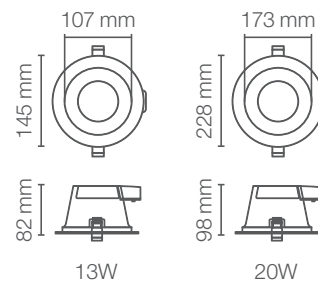

## APLICACIONES / APPLICATIONS



Oficinas  
Offices



Ambientes  
residenciales  
Residential  
environments



Establecimientos  
Shops



Hoteles  
Hotels



Museos  
Museums



Sala de juntas  
Meeting rooms



Pasillos  
Corridors

Código Sku	Potencia Power (W)	Equivalencia Equivalence CFL (W)	Flujo Luminoso Luminous Flux (lm)	Ángulo de Apertura Opening Angle	Temp. de Color Color Temp. (K)	IRC CRI	Vida Útil Life (h)	Dimensiones Dimensions (mm)	Color de Producto Product Color	Unidades por Caja Units per box
86814	13	2 x 18	(3000 K) 1 030 (4000 K) 1 210 (5700 K) 1 110	60°	3000 4000 5700	>80	50 000	Ø 145 x 82	Blanco	8
86816	20	2 x 23	(3000 K) 1 720 (4000 K) 1 930 (5700 K) 1 810	60°	3000 4000 5700	>80	50 000	Ø 228 x 98	Blanco	8



\* En sustitución de lámparas CFL compactas / In the replacement of compact CFL lamps.

Contenido relacionado con este producto en Realidad Aumentada



# LEDVANCE® LINEAR

Luminaria de techo para sobreponer con diseño lineal y moderno. Equipada con LED de alta potencia, que ilumina el ambiente de manera uniforme. Disponible en temperaturas de color: Luz Cálida (3000 K), Blanco Frío (4000 K) y Luz de Día (6500 K). No es necesario el uso de lámparas complementarias.

Indoor lighting with a linear and modern design. Equipped with high power led with day light and cool light, it lights up uniformly the environment. Easy and fast installing. Available in versions: Warm Light (3000 K), Cool Light (4000 K) and Day Light (6500 k). No need additional lamps.





- 

HASTA  
50%  
DE  
ECONOMÍA

SAVES UP TO  
SAVINGS
- 

3  
AÑOS DE  
GARANTÍA

YEAR  
WARRANTY
- 

100 - 240 V~
- 

DISTRIBUCIÓN  
DE LUZ  
UNIFORME

UNIFORM  
DISTRIBUTION  
OF LIGHT
- 

INTERCONECTABLE  
HASTA 10  
LUMINARIAS

INTERCONNECTABLE  
UP TO 10  
LUMINAIRES
- 

IP 20

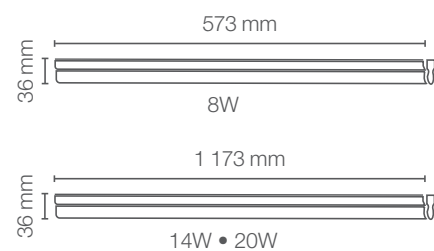

## APLICACIONES / APPLICATIONS



Código Sku	Potencia Power (W)	Equivalencia Equivalence Fluor. (W)	Flujo Luminoso Luminous Flux (lm)	Ángulo de Apertura Opening Angle	Temp. de Color Color Temp. (K)	IRC CRI	Vida Útil Life (h)	Dimensiones Dimensions (mm)	Color de Producto Product Color	Unidades por Caja Units per box
86510	8	1 x 17 T8	800	100°	● 3000	>80	30 000	573 x 28 x 36	Blanco	15
86398	8	1 x 17 T8	800	100°	○ 4000	>80	30 000	573 x 28 x 36	Blanco	15
86399	8	1 x 17 T8	800	100°	● 6500	>80	30 000	573 x 28 x 36	Blanco	15
86512	14	1 x 25 T8	1 400	100°	● 3000	>80	30 000	1173 x 28 x 36	Blanco	15
86400	14	1 x 25 T8	1 400	100°	○ 4000	>80	30 000	1173 x 28 x 36	Blanco	15
86401	14	1 x 25 T8	1 400	100°	● 6500	>80	30 000	1173 x 28 x 36	Blanco	15
86514	20	1 x 32 T8	2 000	100°	● 3000	>80	30 000	1173 x 28 x 36	Blanco	15
86402	20	1 x 32 T8	2 000	100°	○ 4000	>80	30 000	1173 x 28 x 36	Blanco	15
86403	20	1 x 32 T8	2 000	100°	● 6500	>80	30 000	1173 x 28 x 36	Blanco	15

\* En sustitución de lámparas fluorescentes tubulares / In replacement of tubular fluorescent lamps.



# LEDVANCE® LINEAR PENDANT

Luminaria de techo para suspender, ahora con mayor eficiencia que le garantiza la mejor iluminación para espacios comerciales y corporativos, luzca un ambiente elegante y sofisticado gracias a su iluminación directa e indirecta la cual a su vez ayuda a mitigar el efecto caverna.

Ceiling luminaire to suspend, now with greater efficiency that guarantees the best lighting for commercial and corporate spaces, looks elegant and sophisticated thanks to its direct and indirect lighting which in turn helps to mitigate the cavern effect.



- HASTA 40% DE ECONOMÍA**

SAVES UP TO SAVINGS
- 5 AÑOS DE GARANTÍA**

YEAR WARRANTY
- 100 - 277 V~
- IP 20**
- IK 06**
- LUZ DIRECTA E INDIRECTA



## APLICACIONES / APPLICATIONS



Código Sku	Potencia Power (W)	Equivalencia Fluor. (W)	Flujo Luminoso Luminous Flux (lm)	Ángulo de Apertura Opening Angle	Temp. de Color Color Temp. (K)	IRC CRI	Vida Útil Life (h)	Dimensiones Dimensions (mm)	Color de Producto Product Color	Unidades por Caja Units per box
80179	36	2 x 28W T5 2 x 32W T8	3 300	110°	○ 4000	>80	50 000	1024 x 72 x 65	Blanco	6

\* En sustitución de lámparas fluorescentes tubulares / In replacement of tubular fluorescent lamps.





# LEDVANCE® PENDULUM

Accesorio para lámparas LED e Incandescentes con base E27 ideal para crear una atmósfera clásica y retro. Combinable con diferentes ambientes y propuestas decorativas.

Accessory for LED and incandescent lamps with E27 base ideal to create a classic and retro atmosphere. Combination with different environments and decorative proposals.



\*Lámpara no incluida

- LONGITUD AJUSTABLE  
HASTA 1 METRO  
ADJUSTABLE LENGTH  
UP TO 1 METER
- 1  
AÑOS DE GARANTÍA  
YEAR WARRANTY
- 100 - 277 V~
- IP 20
- E27
- 2  
COLORES  
COLORS
- 1906

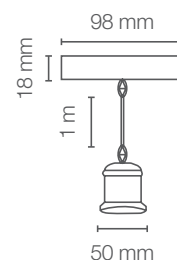

## APLICACIONES / APPLICATIONS

- Salas  
Living
- Recámaras  
Rooms
- Áreas Gastronómicas  
Gastronomic areas
- Restaurantes  
Restaurants
- Establecimientos  
Shops

Compatible con nuestra línea de lámparas LED VINTAGE 1906.

Código Sku	Material	Potencia Max. Max. Power (W)	Base	Dimensiones Dimensions (mm)	Color de Producto Product Color	Unidades por Caja Units per box
86730	Acero	LED 31W o INCANDESCENTE 40W	E27	Ø 98 x 1000	Negro	12
86731	Acero	LED 31W o INCANDESCENTE 40W	E27	Ø 98 x 1000	Bronce	12





# LEDVANCE® TRACKLIGHT

Es una tendencia en la iluminación a detalle, adecuada para aplicaciones comerciales, con una iluminación moderna y decorativa. Ideal para enfocar objetos y destacar espacios.

A trend towards lighting in detail, it is suitable for commercial applications, with modern and decorative lighting, ideal for focusing objects and highlighting spaces.



\*Lámpara no incluida

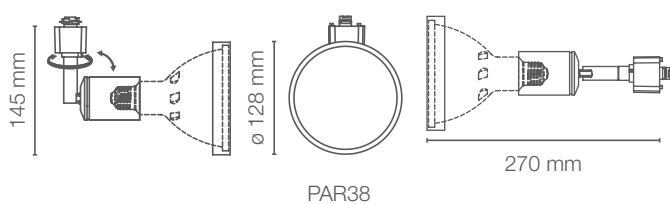
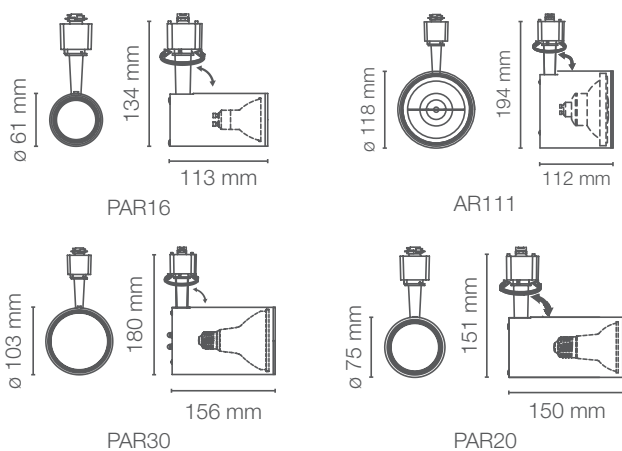

## APLICACIONES / APPLICATIONS

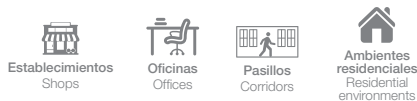

Compatible con nuestra línea de lámparas LED SUPERSTAR.

Código Sku	Versión	Material	Potencia Max. Max. Power (W)	Base	Dimensiones Dimensions (mm)	Peso Weight (g)	Color de Producto Product Color	Unidades por caja Units per box
86636	AR111	Aluminio	14	GU10	112 x 118 x 194	440	Negro	12
86637	AR111	Aluminio	14	GU10	112 x 118 x 194	440	Blanco	12
86632	PAR16	Aluminio	11	GU10	113 x 61 x 134	235	Negro	12
86633	PAR16	Aluminio	11	GU10	113 x 61 x 134	235	Blanco	12
86638	PAR20	Aluminio	7	E27	150 x 75 x 151	340	Negro	12
86639	PAR20	Aluminio	7	E27	150 x 75 x 151	340	Blanco	12
86640	PAR30 LN	Aluminio	31	E27	156 x 103 x 180	425	Negro	12
86641	PAR30 LN	Aluminio	31	E27	156 x 103 x 180	425	Blanco	12
86644	PAR38	Aluminio	16	E27	270 x 128 x 145	288	Negro	12
86645	PAR38	Aluminio	16	E27	270 x 128 x 145	288	Blanco	12

# RIELES Y CONECTORES / RAILS AND CONNECTORS



## RIELES / RAILS

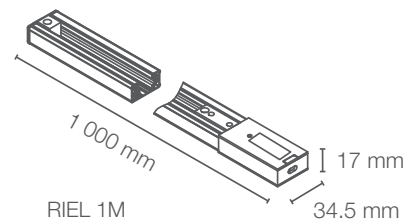
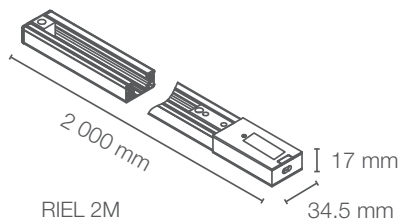

Código Sku	Versión	Material	Potencia Max. Max. Power (W)	Dimensiones Dimensions (mm)	Peso Weight (g)	Color del Producto Product Color	Spots Max. Por Riel Max. Spots Per Rail	Unidades por caja Units per box
86646	Riel 1M	Aluminio	190	1000 x 34.5 x 17	500	Negro	AR111 - 6 PAR16 - 6 PAR20 - 6 PAR30 LN - 4 PAR38 - 4	12
86647	Riel 1M	Aluminio	190	1000 x 34.5 x 17	500	Blanco	AR111 - 6 PAR16 - 6 PAR20 - 6 PAR30 LN - 4 PAR38 - 4	12
86648	Riel 2M	Aluminio	190	2000 x 34.5 x 17	1000	Negro	AR111 - 11 PAR16 - 11 PAR20 - 11 PAR30 LN - 7 PAR38 - 7	12
86649	Riel 2M	Aluminio	190	2000 x 34.5 x 17	1000	Blanco	AR111 - 11 PAR16 - 11 PAR20 - 11 PAR30 LN - 7 PAR38 - 7	12

## CONECTORES / CONNECTORS

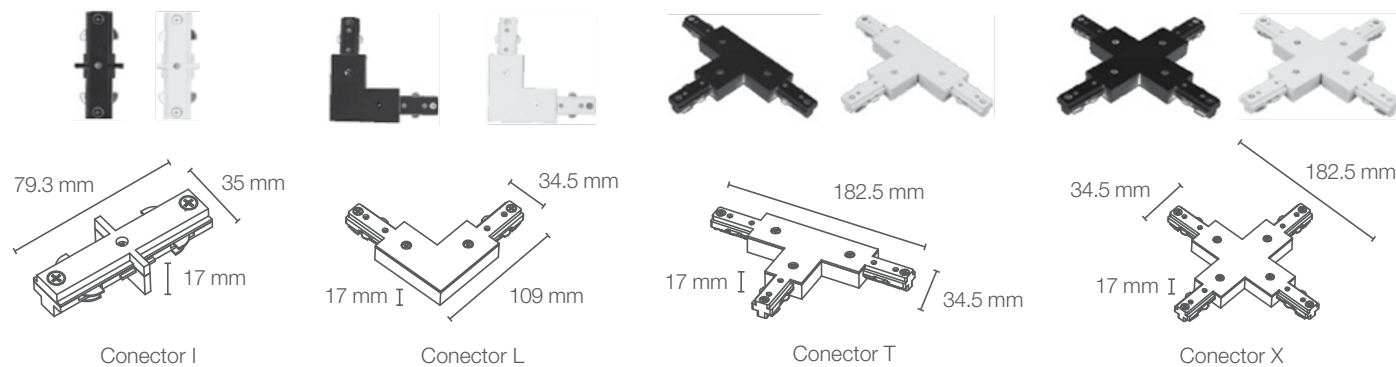

Código Sku	Versión	Material	Potencia Max. Max. Power (W)	Dimensiones Dimensions (mm)	Peso Weight (g)	Color del Producto Product Color	Unidades por caja Units per box
86650	Conector I	Aluminio	190	79.3 x 35 x 17	28	Negro	12
86651	Conector I	Aluminio	190	79.3 x 35 x 17	28	Blanco	12
86652	Conector L derecho	Aluminio	190	109 x 34.5 x 17	104	Negro	12
86653	Conector L derecho	Aluminio	190	109 x 34.5 x 17	104	Blanco	12
86758	Conector L izquierdo	Aluminio	190	109 x 34.5 x 17	104	Negro	12
86759	Conector L izquierdo	Aluminio	190	109 x 34.5 x 17	104	Blanco	12
86722	Conector T derecho	Aluminio	190	182.5 x 34.5 x 17	148	Negro	12
86723	Conector T derecho	Aluminio	190	182.5 x 34.5 x 17	148	Blanco	12
86760	Conector T izquierdo	Aluminio	190	182.5 x 34.5 x 17	148	Negro	12
86761	Conector T izquierdo	Aluminio	190	182.5 x 34.5 x 17	148	Blanco	12
86724	Conector X	Aluminio	190	182.5 x 34.5 x 17	196	Negro	12
86725	Conector X	Aluminio	190	182.5 x 34.5 x 17	196	Blanco	12

## RECESSED RAIL & FLEXIBLE CONNECTOR



### RIEL PARA EMPOTRAR / RECESSED RAIL

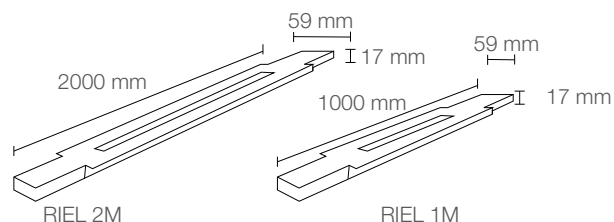

Código Sku	Versión	Material	Potencia Max. Max. Power (W)	Dimensiones Dimensiones (mm)	Peso Weight (g)	Color del Producto Product Color	Spots Max. Por Riel Max. Spots Per Rail	Unidades por caja Units per box
80214	Riel 1M	Aluminio	190	1000x59x17	575	Negro	AR111 - 6 PAR16 - 6 PAR20 - 6 PAR30 LN - 4 PAR38 - 4	12
80215	Riel 1M	Aluminio	190	1000x59x17	575	Blanco	AR111 - 6 PAR16 - 6 PAR20 - 6 PAR30 LN - 4 PAR38 - 4	12
80216	Riel 2M	Aluminio	190	2000x59x17	1120	Negro	AR111 - 11 PAR16 - 11 PAR20 - 11 PAR30 LN - 7 PAR38 - 7	12
80217	Riel 2M	Aluminio	190	2000x59x17	1120	Blanco	AR111 - 11 PAR16 - 11 PAR20 - 11 PAR30 LN - 7 PAR38 - 7	12

### CONECTOR FLEXIBLE / FLEXIBLE CONNECTOR

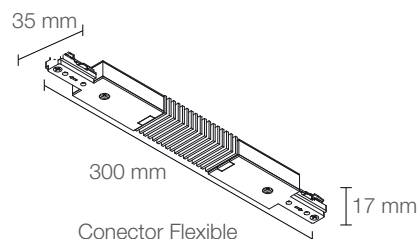

Código Sku	Versión	Material	Potencia Max. Max. Power (W)	Dimensiones Dimensiones (mm)	Peso Weight (g)	Color del Producto Product Color	Unidades por caja Units per box
80218	Conector Flexible	Aluminio	190	300x35x17	155	Negro	12
80219	Conector Flexible	Aluminio	190	300x35x17	155	Blanco	12



# LEDVANCE® MULTISPOT

Ideal para lámparas de alto flujo luminoso, con acabado en aluminio y un diseño elegante, es perfecta para aplicaciones comerciales incluso residenciales. Disponible en 1, 2 y 3 spots con conector eléctrico incluido.

Aluminum housing for PAR30 and AR111 lamps for embedding, with compact design and easy installation. Available for one, two or even three lamps.



\*Lámpara no incluida

100 – 277 V~

PAR30

100 – 240 V~

AR111

IP20

2  
COLORES

COLORES

Compatible con nuestra línea de lámparas LED SUPERSTAR.

## APLICACIONES / APPLICATIONS



Código Sku	Versión	Material	Potencia Max. Max. Power (W)	Base	Dimensiones Dimensions (mm)	Peso Weight (g)	Color de Producto Product Color	Unidades por caja Units per box
86788	1 Lámpara PAR30	Aluminio	37	E27	175 x 175 x 167	460	Negro	8
86771	1 Lámpara PAR30	Aluminio	37	E27	175 x 175 x 167	460	Blanco	8
86766	2 Lámparas PAR30	Aluminio	37	E27	325 x 175 x 167	820	Negro	6
86772	2 Lámparas PAR30	Aluminio	37	E27	325 x 175 x 167	820	Blanco	6
86767	3 Lámparas PAR 30	Aluminio	37	E27	471 x 175 x 167	1240	Negro	6
86773	3 Lámparas PAR 30	Aluminio	37	E27	471 x 175 x 167	1240	Blanco	6
86789	1 Lámpara AR111	Aluminio	14	GU10	175 x 175 x 45	290	Negro	10
86768	1 Lámpara AR111	Aluminio	14	GU10	175 x 175 x 45	290	Blanco	10
86790	2 Lámparas AR111	Aluminio	14	GU10	325 x 175 x 45	540	Negro	10
86769	2 Lámparas AR111	Aluminio	14	GU10	325 x 175 x 45	540	Blanco	10
86791	3 Lámparas AR111	Aluminio	14	GU10	471 x 175 x 45	730	Negro	8
86770	3 Lámparas AR111	Aluminio	14	GU10	471 x 175 x 45	730	Blanco	8



## PAR30 E27

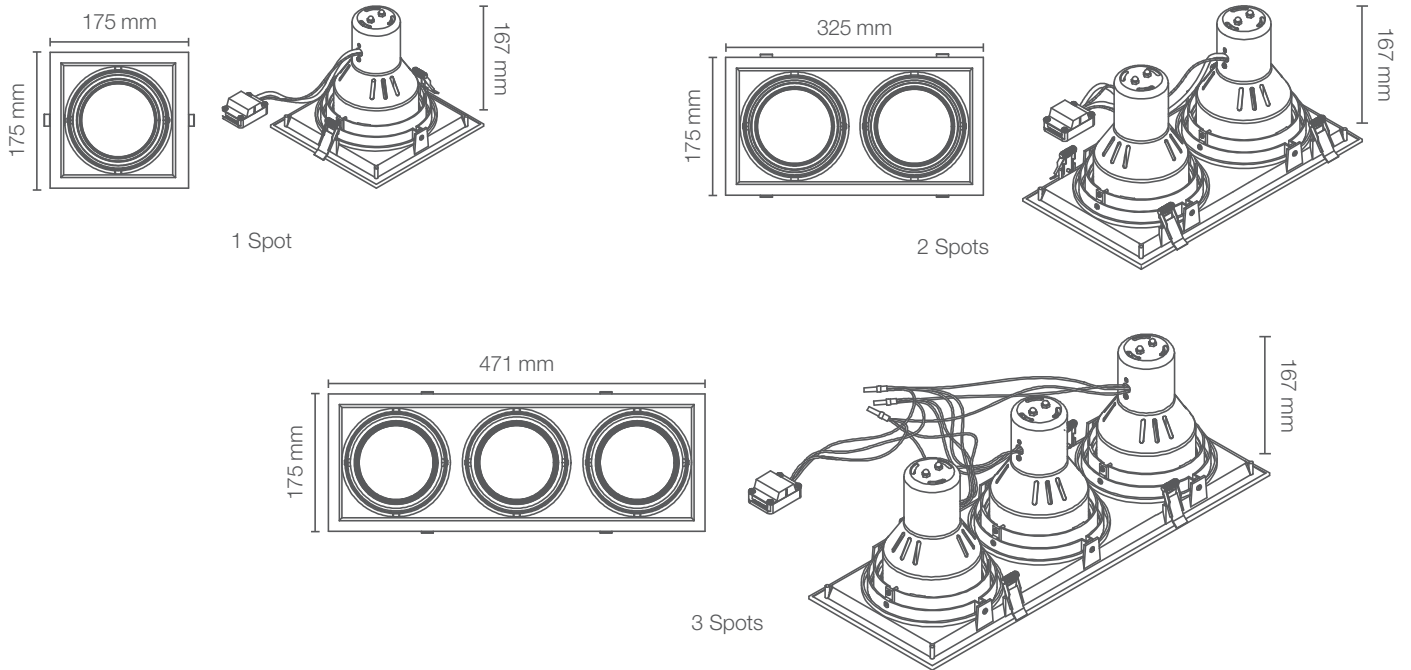

## AR111 GU10

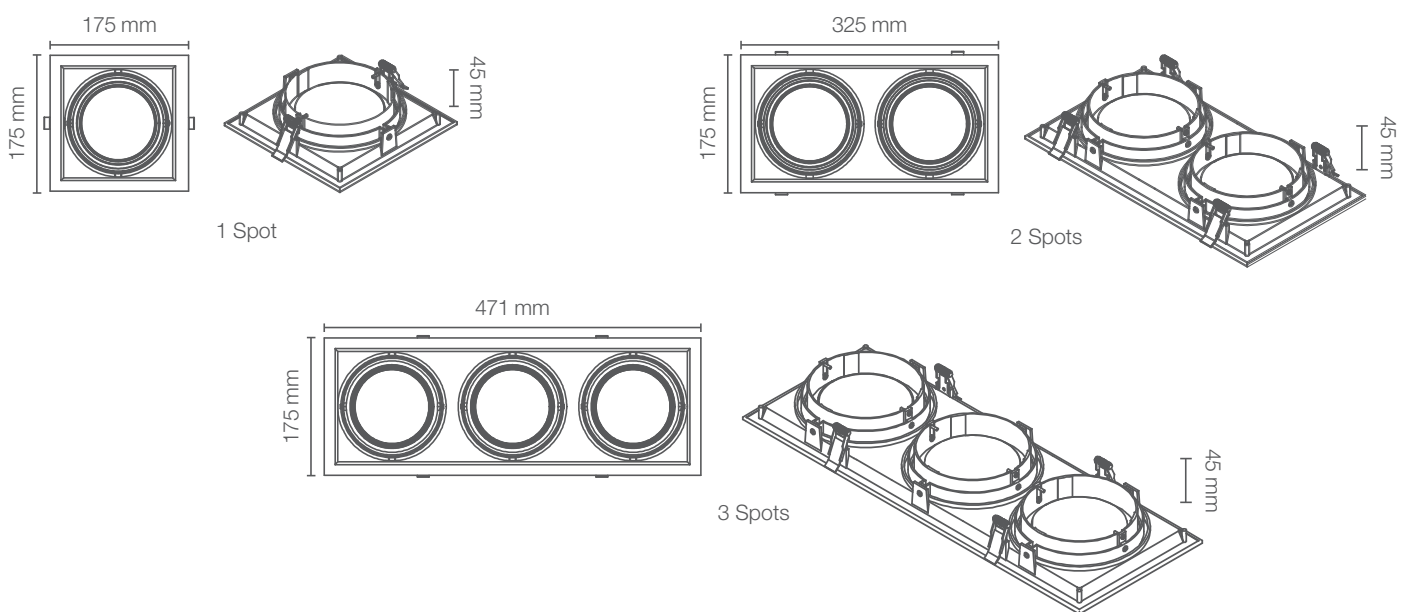



---

# INDUSTRIAL





# LEDVANCE® HIGHBAY 220 V

Luminaria compacta con estructura de aluminio y vidrio templado que le garantiza alta protección IP e IK. Ideal para iluminar espacios entre 12 y 15 metros de altura. Cuenta con protección contra sobretensiones de 4 kV y ángulo de apertura de 105° que le brindará una excelente distribución de luz.

Compact luminaire with aluminum and tempered glass structure that guarantees high IP and IK protection. Ideal for lighting spaces between 12 and 15 meters high. It has 4 kV surge protection and 105 ° beam angle that will provide excellent light distribution.



**HASTA  
60%  
DE  
ECONOMÍA**

SAVES UP TO  
SAVINGS

**3**

ANOS DE  
GARANTÍA

YEAR  
WARRANTY

220 - 240 V-

**IP 65**

**IK 06**

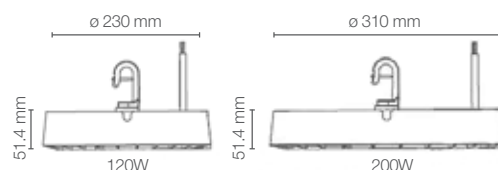

## APLICACIONES / APPLICATIONS



Código Sku	Potencia Power (W)	Equivalencia Equivalence AM (W)	Flujo Luminoso Luminous Flux (lm)	Ángulo de Apertura Opening Angle	Temp. de Color Color Temp. (K)	IRC CRI	Vida Útil Life (h)	Dimensiones Dimensions (mm)	Color de Producto Product Color	Unidades por Caja Units per box
80524	120	1 x 250	12 000	105°	6500	>80	30 000	Ø 230 x 51.4	Negro Mate	1
80525	200	1 x 400	18 000	105°	6500	>80	30 000	Ø 310 x 51.4	Negro Mate	1

\* En sustitución de lámparas de aditivos metálicos / In the replacement of metal halide lamps.





# LEDVANCE® HIGHBAY 135 lm/W

Luminaria profesional ideal para ser utilizada en áreas con techos altos que requieren alta intensidad de luz, tales como estacionamientos, almacenes e industrias. Diseño ligero y compacto, desarrollado con alta tecnología que permite a la luminaria proporcionar un alto flujo luminoso. Resistente a chorros de agua y polvo.

Professional luminaire. Ideal for use areas with high ceilings that require high intensity of light, such as parking lots, warehouses and industries. This product was developed with high technology, which allows the luminaire to provide a high luminous flux in a light and compact design. Resistant to waterjets and dust.



**HASTA  
50%  
DE  
ECONOMÍA**

SAVES UP TO  
SAVINGS

**5**

AÑOS DE  
GARANTÍA

YEAR  
WARRANTY

100-277 V~

**IP65**

**IK08**

**BRACKET  
INCLUIDO**

BRACKET HOOK  
INCLUDED

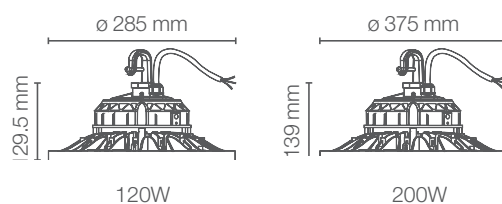

#### APLICACIONES / APPLICATIONS

Hangares  
Hangars

Industrias  
Industries

Áreas públicas  
Public areas

Aeropuertos  
Airports

Establecimientos  
Shops

Código SKU	Potencia Power (W)	Equivalencia Equivalence AM (W)	Flujo Luminoso Luminous Flux (lm)	Ángulo de Apertura Opening Angle	Temp. de Color Color Temp. (K)	IRC CRI	Vida Útil Life (h)	Dimensiones Dimensions (mm)	Atenuable Dimmable	Color de Producto Product Color	Unidades por Caja Units per box
86536	120	1 x 250	16 200	110°	● 5700	>80	50 000	Ø 285 x 129.5	No	Negro Mate	1
86537	200	1 x 400	27 000	110°	● 5700	>80	50 000	Ø 375 x 139	No	Negro Mate	1



\* En sustitución de lámparas de aditivos metálicos / In the replacement of metal halide lamps.

Contenido relacionado con este producto en Realidad Aumentada



# LEDVANCE® HIGHBAY RECESSED

Luminaria de alto flujo luminoso con alto índice de protección contra impactos, es resistente a chorros de agua, lluvia y polvo. Además integra un recubrimiento antiexplosivo (ESD) para mayor seguridad, su aplicación es ideal para zonas que requieren precaución debido al manejo de materiales inflamables. Ideal para alturas de 6 a 15 metros.

LEDVANCE HIGHBAY RECESSED has high luminous flux and high impact protection index, is resistant to waterjets, rain and dust. integrates an ESD coating for greater safety, ideal for areas that require caution due to the handling of flammable materials. For heights of 6 to 15 meters.

Incluye accesorio de seguridad. No es para suspender.



**HASTA 50% DE ECONOMÍA**

SAVES UP TO SAVINGS

**5 AÑOS DE GARANTÍA**

YEAR WARRANTY

**100 - 277 V~**

**IP65**

**IK07**

	A (mm)	B (mm)	C (mm)	D (mm)
100W•150W	595	595	400	108

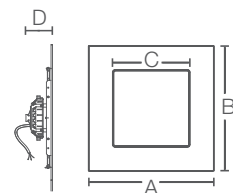

## APLICACIONES / APPLICATIONS



Código Sku	Potencia Power (W)	Equivalencia Equivalence AM (W)	Flujo Luminoso Luminous Flux (lm)	Ángulo de Apertura Opening Angle	Temp. de Color Color Temp. (K)	IRC CRI	Vida Útil Life (h)	Dimensiones Dimensions (mm)	Color de Producto Product Color	Unidades por Caja Units per box
86735	100	1 x 195	13 000	100°	6500	>80	50 000	595 x 595 x 108	Blanco	1
86736	150	1 x 250	19 500	100°	6500	>80	50 000	595 x 595 x 108	Blanco	1

\* En sustitución de lámparas de aditivos metálicos / In the replacement of metal halide lamps.



# LEDVANCE® FLOODLIGHT HIGH WATTAGE 50 000 h

Proyector de LED de alta potencia para iluminación de exteriores. Instalación fácil y rápida. No es necesario el uso de lámparas complementarias.

LED projector for outdoor lighting.  
Easy and fast installing. No need of additional lamps.



**HASTA  
50%  
DE  
ECONOMÍA**

**5  
AÑOS DE  
GARANTÍA**

**IP65**

**IK08**

SAVES UP TO SAVINGS

YEAR WARRANTY



SWIVEL STAND 180°

APLICACIONES / APPLICATIONS

- Jardines  
Gardens
- Entradas principales  
Main entries
- Fachadas  
Facades
- Canchas de fútbol  
Soccer fields
- Áreas públicas  
Public areas
- Áreas recreativas  
Recreative areas
- Estacionamientos  
Parking lots

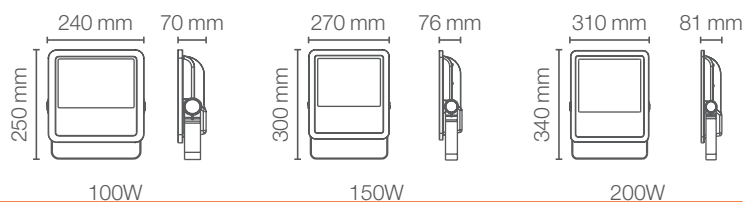

Código Sku	Potencia Power (W)	Equivalencia Equivalence AM (W)	Flujo Luminoso Luminous Flux (lm)	Ángulo de Apertura Opening Angle	Tensión Tension (V~)	Temp. de Color Color Temp. (K)	IRC CRI	Vida Útil Life (h)	Dimensiones Dimensions (mm)	Color de Producto Product Color	Unidades por Caja Units per box
86384	100	1 x 175/200	10 000	100°	100-277	● 5000	>80	50 000	240 x 70 x 250	Negro	1
86385	150	1 x 250	15 000	100°	100-277	● 5000	>80	50 000	270 x 76 x 300	Negro	1
86386	200	1 x 400	20 000	100°	100-277	● 5000	>80	50 000	310 x 81 x 340	Negro	1

\* En sustitución de lámparas de aditivos metálicos / In the replacement of metal halide lamps.





# LEDVANCE® FLOODLIGHT HIGH WATTAGE 30 000 h

Proyector de LED de alta potencia para iluminación de exteriores. Instalación fácil y rápida. No es necesario el uso de lámparas complementarias.

LED projector for outdoor lighting.  
Easy and fast installing. No need of additional lamps.



100W • 150W

200W



HASTA  
50%  
DE  
ECONOMÍA

SAVES UP TO  
SAVINGS



3  
AÑOS DE  
GARANTÍA

YEAR  
WARRANTY



IP65



IK08



SOPORTE  
ROTATIVO  
180°

SWIVEL STAND  
180°



LED SMD

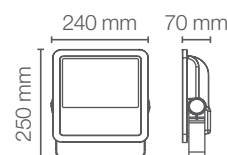

100W • 150W

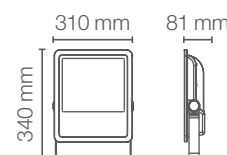

200W

## APLICACIONES / APPLICATIONS

- Jardines  
Gardens
- Entradas principales  
Main entries
- Fachadas  
Facades
- Canchas de fútbol  
Soccer fields
- Áreas públicas  
Public areas
- Áreas recreativas  
Recreative areas
- Estacionamientos  
Parking lots

Código Sk	Potencia Power (W)	Equivalencia Equivalence AM (W)	Flujo Luminoso Luminous Flux (lm)	Ángulo de Apertura Opening Angle	Tensión Tension (V~)	Temp. de Color Color Temp. (K)	IRC CRI	Vida Útil Life (h)	Dimensiones Dimensions (mm)	Color de Producto Product Color	Unidades por Caja Units per box
86682	100	1 x 175/200	10 000	100°	100-277	● 5000	>80	30 000	240 x 70 x 250	Negro	1
86683	150	1 x 250	15 000	100°	100-277	● 5000	>80	30 000	240 x 70 x 250	Negro	1
86684	200	1 x 400	20 000	100°	100-240	● 5000	>80	30 000	270 x 76 x 300	Negro	1

\* En sustitución de lámparas de aditivos metálicos / In the replacement of metal halide lamps.





# LEDVANCE® FLOODLIGHT ASYMMETRICAL

Proyector de LED de alta potencia para iluminación de exteriores hasta 25 metros de altura. Instalación fácil y rápida. No es necesario el uso de lámparas complementarias.

LED projector for outdoor lighting. Easy and fast installing. No need of additional lamps.



**HASTA  
50%  
DE  
ECONOMÍA**

SAVES UP TO  
SAVINGS

**5**

AÑOS DE  
GARANTÍA

YEAR  
WARRANTY

**100 – 277 V~**

**IK08**

**IP 65**

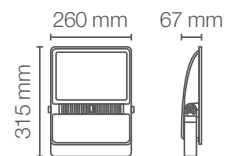

## APLICACIONES / APPLICATIONS



Código Sku	Potencia Power (W)	Equivalencia Equivalence AM (W)	Flujo Luminoso Luminous Flux (lm)	Ángulo de Apertura Opening Angle	Temp. de Color Color Temp. (K)	IRC CRI	Vida Útil Life (h)	Dimensiones Dimensions (mm)	Color de Producto Product Color	Unidades por Caja Units per box
86588	150	1 x 250	13 500	100°	3000	>80	50 000	260 x 67 x 315	Negro	1
86589	150	1 x 250	13 500	100°	5000	>80	50 000	260 x 67 x 315	Negro	1

\* En sustitución de lámparas de aditivos metálicos / In the replacement of metal halide lamps.



# LEDVANCE® FLOODLIGHT HIGH POWER

FLOODLIGHT de alto rendimiento, alta reproducción de color y con protección atmosférica de 6 000 V, adecuada para aplicaciones en espacios amplios. Disponible en versiones de 300 W, 400 W y 600 W con 2 ángulos de apertura 30° y 60°.

FLOODLIGHT high performance, high color reproduction and 6 000 V atmospheric protection, suitable for applications in large spaces. Available in 300 W, 400 W and 600 W versions and two opening angles 30° and 60°.

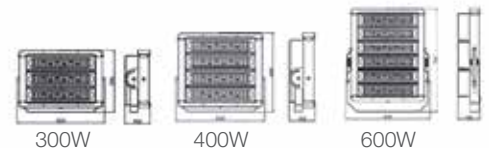

## APLICACIONES / APPLICATIONS



Código Sku	Potencia Power (W)	Equivalencia Equivalence AM (W)	Flujo Luminoso Luminous Flux (lm)	Ángulo de Apertura Opening Angle	Temp. de Color Color Temp. (K)	IRC CRI	Vida Útil Life (h)	Dimensiones Dimensions (mm)	Color de Producto Product Color	Unidades por Caja Units per box
86798	300	1 x 600	36000	30°	● 5700	>80	50 000	522X152X370	Negro	1
86799	400	1 X 750	48000	30°	● 5700	>80	50 000	522X152X466	Negro	1
86801	600	1 X 1000	72000	30°	● 5700	>80	50 000	575X152X700	Negro	1
86742	300	1 x 600	36000	60°	● 5700	>80	50 000	522X152X370	Negro	1
86743	400	1 X 750	48000	60°	● 5700	>80	50 000	522X152X466	Negro	1
86745	600	1 X 1000	72000	60°	● 5700	>80	50 000	575X152X700	Negro	1

\* En sustitución de lámparas de aditivos metálicos / In the replacement of metal halide lamps.





# LEDVANCE® FLOODLIGHT HIGH POWER 1KW

Potente reflector de 1000 W con lente de policarbonato, brazo ajustable de 320° y acabado en inyección de aluminio resistente a radiación UV. Con una eficiencia de 120 lm/W, tres diferentes ángulos de apertura 8° / 12° / 30° y además supresor de picos de voltaje de 10kV. Seguridad y ahorro de energía en un solo producto.

Powerful 1000 W reflector with polycarbonate lens, adjustable 320° arm and aluminum injection finish with an efficiency of 120 lm/W, three different opening angles 8° / 12° / 30° and also surge suppressor of voltage of 10kV. Suppressor of voltage of 10kV. Safety and energy saving in one product.



**5**  
AÑOS DE GARANTÍA  
YEAR WARRANTY

**0 100**  
ATENUABLE  
DIMMING

PROTECCIÓN CONTRA SOBRETENSIONES  
**10kV**

SOPORTE ROTATIVO  
**320°**  
SWIVEL STAND  
320°

**IP 66**

**IK08**

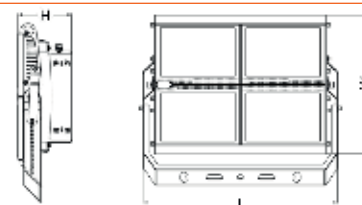

## APLICACIONES / APPLICATIONS



	L	X	W	X	H (MM)
8°	710		507.8		195
12° / 30°	710		507.8		109.5

Código Sku	Potencia Power (W)	Equivalencia Equivalence AM (W)	Flujo Luminoso Luminous Flux (lm)	Ángulo de Apertura Opening Angle	Temp. de Color Color Temp. (K)	IRC CRI	Vida Útil Life (h)	Dimensiones Dimensions (mm)	Color de Producto Product Color	Unidades por Caja Units per box
80366	1 000	1 x 2000	120 000	8°	5700	>80	50 000	710X507.8X195	Gris	1
80367	1 000	1 x 2000	120 000	12°	5700	>80	50 000	710X507.8X109.5	Gris	1
80368	1 000	1 x 2000	120 000	30°	5700	>80	50 000	710X507.8X109.5	Gris	1

\* En sustitución de lámparas de aditivos metálicos / In the replacement of metal halide lamps.



# LEDVANCE® DAMP-PROOF HOUSING

Luminaria diseñada para tubos de LED T5 y T8 en versiones de 60 cm y 120 cm. Brinda protección contra el ingreso de líquidos y polvo gracias al sellado hermético que proporcionan sus clips laterales, además de un alto grado de protección contra impactos mecánicos debido a su fabricación en ABS y Policarbonato, polímeros de alta resistencia a impactos mecánicos y altas temperaturas.

Luminaire designed for T5 and T8 LED tubes, in 60 cm and 120 cm versions. Provides protection against ingress of liquids and dust thanks to the hermetic sealing provided by its side clips, in addition to a high degree of protection against mechanical impacts due to its manufacture in ABS and Polycarbonate, polymers of high resistance to mechanical impacts and high temperatures.



**3**  
AÑOS DE GARANTÍA  
YEAR WARRANTY

COMPATIBLE CON TUBOS LED  
NO INCLUIDOS  
COMPATIBLE WITH LED TUBES  
NOT INCLUDED

VERSIÓN PARA  
**1 o 2**  
LÁMPARAS  
VERSION FOR  
1 OR 2 LAMPS

120 ~ 277 V ~

**IP65**

**IK08**

CLIPS EN PC  
ALTA DURABILIDAD  
HIGH DURABILITY  
PC CLIPS

DIFUSOR EN  
POLICARBONATO  
POLYCARBONATE  
DIFFUSER

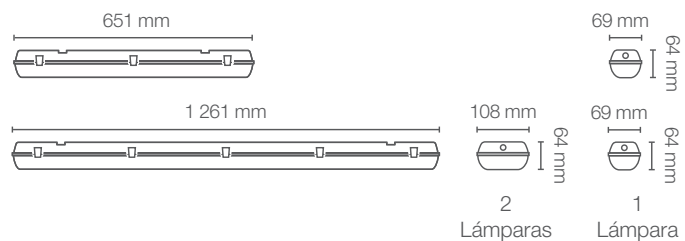

## APLICACIONES / APPLICATIONS

-   
 Cámaras frigoríficas  
Cold rooms
-   
 Industrias  
Industries
-   
 Estacionamientos  
Parking lots
-   
 Vapores y Saunas  
Vapors and Saunas

Código SKU	Versión	Material	Potencia Max. Max. Power (W)	Dimensiones Dimensions (mm)	Peso Weight (g)	Color de Producto Product Color	Unidades por Caja Units per box
80461	2 Lámparas	Plástico / Policarbonato	2 x 10	651x69x64	550	Gris	6
80462	1 Lámpara	Plástico / Policarbonato	1 x 20	1261x69x64	710	Gris	8
80463	2 Lámparas	Plástico / Policarbonato	2 x 20	1261x108x64	900	Gris	6



Contenido relacionado con este producto en Realidad Aumentada





# LEDVANCE® DAMP-PROOF LED

Luminaria con difusor en policarbonato para sobreponer con diseño lineal y moderno. Equipada con LED de alta potencia con luz blanca y fría, que ilumina el ambiente de manera uniforme. Instalación fácil y rápida. Disponible en temperaturas de color: Blanco Frío (4000 K) y Luz de Día (6500 K). No es necesario el uso de lámparas complementarias.

Indoor lighting with PC diffuser and modern design. Equipped with high power led with day light and cool light, it lights up uniformly the environment. Easy and fast installing. Available in two versions, Cool Light (4000 K) and Day Light (6500 K). No need additional lamps.



- HASTA 50% DE ECONOMÍA**

SAVES UP TO SAVINGS
- 3 AÑOS DE GARANTÍA**

YEAR WARRANTY 18W / 36W
- 5 AÑOS DE GARANTÍA**

YEAR WARRANTY 57W
- 100 - 277 V~**
- IP65**
- IK08**

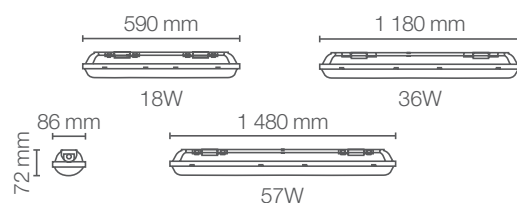

## APLICACIONES / APPLICATIONS

- Cámaras frigoríficas  
Cold rooms
- Hangares  
Hangars
- Industrias  
Industries
- Estacionamientos  
Parking lots
- Vapores y Saunas  
Vapors and Saunas

Código Sku	Potencia Power (W)	Equivalencia Equivalence Fluor. (W)	Flujo Luminoso Luminous Flux (lm)	Ángulo de Apertura Opening Angle	Temp. de Color Color Temp. (K)	IRC CRI	Vida Útil Life (h)	Dimensiones Dimensions (mm)	Color de Producto Product Color	Unidades por Caja Units per box
86392	18	2 x 17 T8	1 800	100°	○ 4000	>80	30 000	590 x 86 x 72	Blanco	12
86393	18	2 x 17 T8	1 800	100°	● 6500	>80	30 000	590 x 86 x 72	Blanco	12
86394	36	2 x 32 T8	3 600	100°	○ 4000	>80	30 000	1180 x 86 x 72	Blanco	8
86395	36	2 x 32 T8	3 600	100°	● 6500	>80	30 000	1180 x 86 x 72	Blanco	8
86396	57	2 x 54 T5 o 2 x 59 T8	5 700	100°	○ 4000	>80	50 000	1480 x 86 x 72	Blanco	8
86397	57	2 x 54 T5 o 2 x 59 T8	5 700	100°	● 6500	>80	50 000	1480 x 86 x 72	Blanco	8



\* En sustitución de lámparas fluorescentes tubulares / In replacement of tubular fluorescent lamps.

Contenido relacionado con este producto en Realidad Aumentada



# LEDVANCE® DAMP-PROOF SENSOR

Luminaria para uso consciente de energía debido al ahorro proporcionado por el sensor de presencia y su temporizador integrado. Su instalación es simple y no requiere sistemas adicionales, ni lámparas complementarias.

Luminaire for an energy conscious consumption thanks due to the savings provided by the presence sensor and its integrated timer. Its installation is simple and does not require additional systems. No need additional lamps.

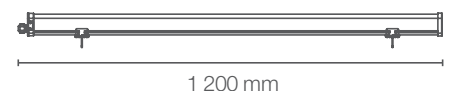
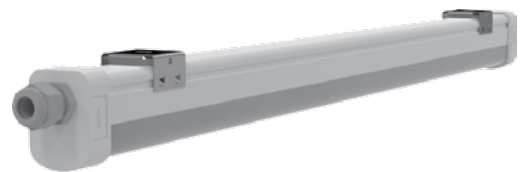

<b>HASTA 50% DE ECONOMÍA</b> SAVES UP TO SAVINGS	<b>3 AÑOS DE GARANTÍA</b> YEAR WARRANTY	<b>100 - 277 V~</b>	<b>IP65</b>	<b>FOTOCELDA ACTIVA</b> ACTIVE PHOTOCELL	<b>TEMPORIZADOR 60 SEG</b> 60 SECONDS TIMER
<b>DISTANCIA 3 m</b> MAXIMUM DISTANCE 3m	<b>SENSOR NO PROGRAMABLE</b>				

## APLICACIONES / APPLICATIONS



Código Sku	Potencia Power (W)	Equivalencia Fluor. (W)	Flujo Luminoso Luminous Flux (lm)	Ángulo de Apertura Opening Angle	Temp. de Color Color Temp. (K)	IRC CRI	Vida Útil Life (h)	Dimensiones Dimensions (mm)	Color de Producto Product Color	Unidades por Caja Units per box
86792	30	2 x 32 T8	3 300	100°	6500	>80	30 000	1200 x 56.4 x 70.2	Blanco	6

\* En sustitución de lámparas fluorescentes tubulares / In replacement of tubular fluorescent lamps.



# LEDVANCE® WALL PACK

Luminaria para sobreponer en muro, con estructura de aluminio extruido resistente a impactos mecánicos de grado IK08, para aplicaciones exteriores gracias a la hermeticidad que le brinda su IP65. Adquiera la iluminación ideal de acuerdo a sus necesidades gracias a la atenuación que le permite el controlador de la luminaria, así como también le brinda un rendimiento de hasta 130 lm/W.

Luminaire to be superimposed on the wall, with an extruded aluminum structure resistant to mechanical impacts of IK08 grade, for exterior applications thanks to the hermeticity provided by its IP65. Acquire the ideal lighting according to your needs thanks to the dimming allowed by the luminaire controller, as well as giving you a performance of up to 130 lm/W.



**HASTA 80% DE ECONOMÍA**

SAVES UP TO SAVINGS

**5 AÑOS DE GARANTÍA**

YEAR WARRANTY

**FULL CUTOFF**

**PROTECCIÓN CONTRA SOBRETENSIONES 2kV**

**0 100 ATENUABLE**

DIMMING

**120-277 V~**

**UL**

**IP 65**

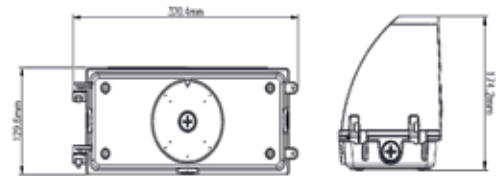

## APLICACIONES / APPLICATIONS



Código Sku	Potencia Power (W)	Equivalencia Equivalence AM (W)	Flujo Luminoso Luminous Flux (lm)	Ángulo de Apertura Opening Angle	Temp. de Color Color Temp. (K)	IRC CRI	Vida Útil Life (h)	Dimensiones Dimensions (mm)	Color de Producto Product Color	Unidades por Caja Units per box
80432	28	175	3640	110°	○ 4000	>80	50 000	320.4X129.6X174.2	Gris Oscuro	4
80433	28	175	3640	110°	● 6500	>80	50 000	320.4X129.6X174.2	Gris Oscuro	4
80434	45	250	5850	110°	○ 4000	>80	50 000	320.4X129.6X174.2	Gris Oscuro	4
80435	45	250	5850	110°	● 6500	>80	50 000	320.4X129.6X174.2	Gris Oscuro	4
80436	70	400	9100	110°	○ 4000	>80	50 000	320.4X129.6X174.2	Gris Oscuro	4
80437	70	400	9100	110°	● 6500	>80	50 000	320.4X129.6X174.2	Gris Oscuro	4

\* En sustitución de lámparas de aditivos metálicos / In the replacement of metal halide lamps.

---

# EXTERIOR







# LEDVANCE® SPIKE

La nueva línea de luminarias para jardín de LEDVANCE combina calidad y confianza, dos aspectos decisivos para la aplicación en exteriores. Con alta resistencia y durabilidad, la línea LEDVANCE SPIKE está especialmente diseñada para resistir en áreas externas con grado de protección IP67 e IK08.

The new line LEDVANCE SPIKE combines quality and reliability, two decisive aspects for outdoor applications. With high strength and durability, these luminaires is specially designed to resist in external areas with high index protection IP67 and IK08.



**2**  
AÑOS DE GARANTÍA  
YEAR WARRANTY

**FÁCIL INSTALACIÓN**  
EASY TO INSTALL

**100 – 240 V~**

**IP67**

**INCLUYE LLAVE HEXAGONAL**  
INCLUDES HEXAGONAL WRENCH

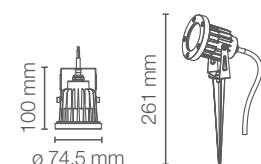

## APLICACIONES / APPLICATIONS

**Ambientes residenciales**  
Residential environments

**Jardines**  
Gardens

**Entradas principales**  
Main entries

**Áreas recreativas**  
Recreative areas

**Áreas públicas**  
Public areas

Código Sku	Potencia Power (W)	Equivalencia Equivalence Halógena (W)	Flujo Luminoso Luminous Flux (lm)	Ángulo de Apertura Opening Angle	Temp. de Color Color Temp. (K)	IRC CRI	Vida Útil Life (h)	Dimensiones Dimensions (mm)	Color de Producto Product Color	Unidades por Caja Units per box
86634	5	45	350	24°	3000	>80	15 000	Ø 74.50 x 261	Negro	30
86635	5	45	350	24°	5000	>80	15 000	Ø 74.50 x 261	Negro	30
86642	9	65	720	30°	3000	>80	15 000	Ø 74.50 x 261	Negro	30
86643	9	65	720	30°	5000	>80	15 000	Ø 74.50 x 261	Negro	30

\* En sustitución de lámparas halógenas convencionales / In the replacement of conventional halogen lamps.





# LEDVANCE® WALL LIGHT APLIQUE SINGLE & DUAL HOUSING

Luminarias decorativas para uso interior y exterior en versión housing.

Gracias a su base GU10 integrada se logra una combinación de APLIQUE + Lámpara PAR16 posibilitando aplicaciones con diferentes temperaturas de color (Luz Cálida, Blanco Frío, Luz de Día o hasta RGB).

Decorative luminaires for indoor and outdoor use in housing.

Thanks to its integrated GU10 base, a combination of APLIQUE + PAR16 lamp is achieved, enabling applications with different color temperatures (Warm Light, Cool Light, Day Light or even RGB light).

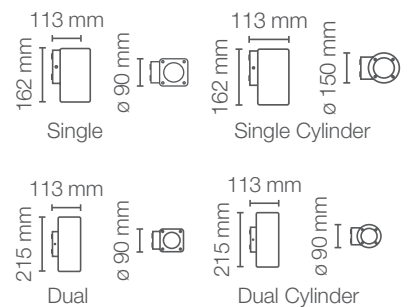

## APLICACIONES / APPLICATIONS



Compatible con nuestra línea de lámparas  
LED SUPERSTAR PAR16.

Código Sku	Versión	Material	Potencia Max. Max. Power (W)	Base	Dimensiones Dimensions (mm)	Peso Weight (g)	Color de Producto Product Color	Unidades por caja Units per box
86603	Single	Policarbonato	1 x 11	GU10	□ 90 x 113 x 162	371	Negro	16
86602	Single	Policarbonato	1 x 11	GU10	□ 90 x 113 x 162	371	Blanco	16
86600	Single Cylinder	Policarbonato	1 x 11	GU10	○ 90 x 113 x 162	413	Negro	16
86601	Single Cylinder	Policarbonato	1 x 11	GU10	○ 90 x 113 x 162	413	Blanco	16
86596	Dual	Policarbonato	2 x 11	GU10	□ 90 x 113 x 215	558	Negro	16
86597	Dual	Policarbonato	2 x 11	GU10	□ 90 x 113 x 215	558	Blanco	16
86599	Dual Cylinder	Policarbonato	2 x 11	GU10	○ 90 x 113 x 215	498	Negro	16
86598	Dual Cylinder	Policarbonato	2 x 11	GU10	○ 90 x 113 x 215	498	Blanco	16





# LEDVANCE® WALL LIGHT DECOLED

Luminarias decorativas para uso interior y exterior en versión led integrado.

Decorative luminaires for indoor and outdoor use in integrated LED version.

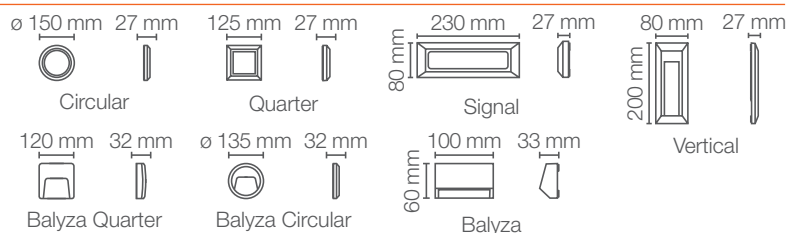
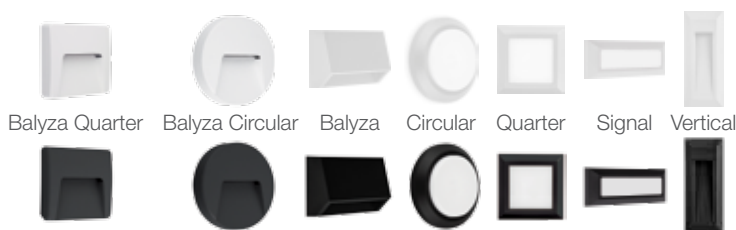

## APLICACIONES / APPLICATIONS

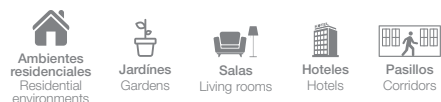

Código Sku	Versión	Potencia Power (W)	Flujo Luminoso Luminous Flux (lm)	Ángulo de Apertura Opening Angle	Temp. de Color Color Temp. (K)	IRC CRI	Vida Útil Life (h)	Dimensiones Dimensions (mm)	Color de Producto Product Color	Unidades por caja Units per box
86610	Circular	3	150	110°	3000	>80	30 000	Ø 150 x 27	Negro	24
86611	Circular	3	150	110°	3000	>80	30 000	Ø 150 x 27	Blanco	24
86608	Quarter	3	150	110°	3000	>80	30 000	125 x 125 x 27	Negro	24
86609	Quarter	3	150	110°	3000	>80	30 000	125 x 125 x 27	Blanco	24
86604	Signal	4	180	110°	3000	>80	30 000	230 x 80 x 27	Negro	24
86605	Signal	4	180	110°	3000	>80	30 000	230 x 80 x 27	Blanco	24
86606	Vertical	1	30	140°	3000	>80	30 000	80 x 200 x 27	Negro	24
86607	Vertical	1	30	140°	3000	>80	30 000	80 x 200 x 27	Blanco	24
86612	Balyza	1.5	70	160°	3000	>80	30 000	100 x 60 x 33	Negro	24
86613	Balyza	1.5	70	160°	3000	>80	30 000	100 x 60 x 33	Blanco	24
86689	Balyza Quarter	3	100	112°	3000	>80	30 000	120 x 120 x 32	Negro	24
86690	Balyza Quarter	3	100	112°	3000	>80	30 000	120 x 120 x 32	Blanco	24
86691	Balyza Circular	3	100	104°	3000	>80	30 000	Ø 135 x 32	Negro	24
86692	Balyza Circular	3	100	104°	3000	>80	30 000	Ø 135 x 32	Blanco	24



# LEDVANCE® ENDURA

Elegante línea decorativa de luminarias LED para uso interior y exterior con diseño sofisticado.

Elegant decorative line of LED luminaires for indoor and outdoor use with sophisticated design.

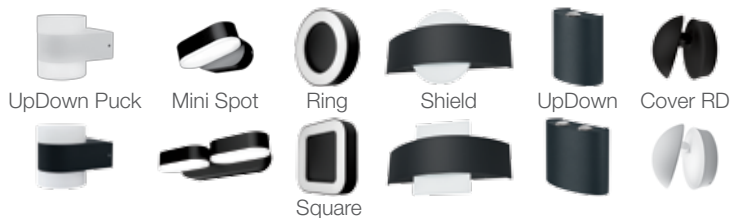

5  
AÑOS DE GARANTÍA

YEAR WARRANTY



FÁCIL INSTALACIÓN

EASY TO INSTALL



100 - 277 V~



IP44

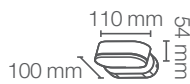

Mini Spot

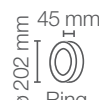

Ring



Shield



UpDown

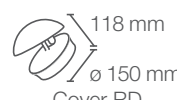

Cover RD

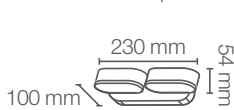

Square



UpDown Puck

## APLICACIONES / APPLICATIONS



Ambientes residenciales  
Residential environments



Jardines  
Gardens



Salas  
Living rooms



Hoteles  
Hotels



Pasillos  
Corridors

Código Sku	Versión	Potencia Power (W)	Flujo Luminoso Luminous Flux (lm)	Ángulo de Apertura Opening Angle	Temp. de Color Color Temp. (K)	IRC CRI	Vida Útil Life (h)	Dimensiones Dimensions (mm)	Color de Producto Product Color	Unidades por caja Units per box
86866	UpDown Deco I	6	280	40°	3000	>80	30 000	130 x 100 x 50	Gris Oscuro	6
86867	UpDown Deco II	11	550	40°	3000	>80	30 000	130 x 140 x 50	Gris Oscuro	6
86868	UpDown Puck	13	980	120°	3000	>80	30 000	131 x 110 x 91	Gris Oscuro	6
86869	UpDown Puck	13	980	120°	3000	>80	30 000	131 x 110 x 91	Blanco	6
86876	Ring	13	500	100°	3000	>80	30 000	∅ 202 x 45	Gris Oscuro	6
86877	Square	13	500	100°	3000	>80	30 000	202 x 202 x 45	Gris Oscuro	6
86878	Mini Spot I	8	320	100°	3000	>80	30 000	100 x 110 x 54	Gris Oscuro	6
86879	Mini Spot II	13	800	100°	3000	>80	30 000	100 x 230 x 54	Gris Oscuro	6
86880	Cover RD	13	640	100°	3000	>80	30 000	∅ 150 x 142	Gris Oscuro	4
86881	Cover RD	13	640	100°	3000	>80	30 000	∅ 150 x 142	Blanco	4
86882	Shield RD	11	400	340°	3000	>80	30 000	142 x 240 x 60	Gris Oscuro	6
86883	Shield SQ	11	400	340°	3000	>80	30 000	142 x 240 x 60	Gris Oscuro	6



# LEDVANCE® BOLLARD

La línea de luminarias para jardín LEDVANCE BOLLARD permite diversos tipos de iluminación en un mismo producto, gracias a su base GU10 integrada se logra una combinación de BOLLARD + Lámpara PAR16 posibilitando aplicaciones con diferentes temperaturas de color (Luz Cálida, Blanco Frío, Luz de Día o hasta RGB). Disponible en versiones cuadrado y redondo con acabado en aluminio y protección IP54, ideales para iluminación elegante y decorativa en ambientes externos.

The garden luminaires LEDVANCE BOLLARD line luminaires allows different types of lighting in the same product, thanks to its integrated GU10 base, a combination of BOLLARD + PAR16 lamp is achieved, enabling applications with different color temperatures (Warm Light, Cool Light, Day Light or even RGB light).

Available in square and round versions models with aluminum finish and IP54 protection, ideal for elegant and decorative lighting in external environments.



Compatible únicamente con LED  
Compatible only with LED

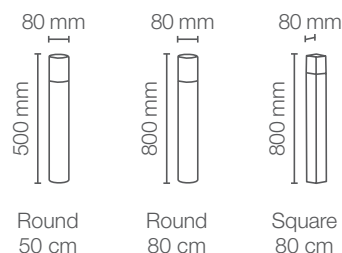

## APLICACIONES / APPLICATIONS



Compatible con nuestra línea de lámparas  
LED SUPERSTAR PAR16.

Código Sku	Versión	Material	Potencia Max. Max. Power (W)	Base	Dimensiones Dimensions (mm)	Peso Weight (g)	Color de Producto Product Color	Unidades por Caja Units per box
86554	Round 50cm	Aluminio	11	GU10	○ Ø 80 x 500	800	Negro	4
86556	Round 80cm	Aluminio	11	GU10	○ Ø 80 x 800	1213	Negro	4
86557	Square 80cm	Aluminio	11	GU10	□ 80 x 80 x 800	1423	Negro	4





# LEDVANCE® FLOODLIGHT BLANCO Y NEGRO

Proyector de LED para iluminación de exteriores, elaborado con materiales de alta calidad, resistente a chorros de agua, lluvia y polvo. Tiene un diseño compacto y moderno, difusor en vidrio templado esmerilado antirreflejante. No necesita lámparas complementarias. Disponible en temperaturas de color: Luz Cálida (3000 K) y Blanco Frío (5000 K).

LED projector for outdoor lighting, made with high quality materials, resistant to waterjets, rain and dust. It has a compact and modern design, anti-glare frosted tempered glass diffuser. No additional lamps needed. Available in Warm Light temperature (3000 K) and Cool Light (5000 K) versions.



Contenido relacionado con este producto en Realidad Aumentada

**HASTA 80% DE ECONOMÍA**

SAVES UP TO SAVINGS

**3 AÑOS DE GARANTÍA**

YEAR WARRANTY

**100 - 240 V~**

**IP65**

**LED SMD**

**SOPORTE ROTATIVO 180°**

SWIVEL STAND 180°

**DRIVER INTEGRADO**

BUILT-IN DRIVER

115 mm 39 mm  
125 mm

10W

150 mm 42 mm  
140 mm

30W

180 mm 46 mm  
155 mm

50W

## APLICACIONES / APPLICATIONS



Código Sku	Potencia Power (W)	Equivalencia Equivalence AM (W)	Flujo Luminoso Luminous Flux (lm)	Ángulo de Apertura Opening Angle	Temp. de Color Color Temp. (K)	IRC CRI	Vida Útil Life (h)	Dimensiones Dimensions (mm)	Color de Producto Product Color	Unidades por Caja Units per box
82882	10	1 x 50 Hal.	800	100°	● 3000	>80	30 000	115 x 39 x 125	Negro	10
82883	10	1 x 50 Hal.	800	100°	● 5000	>80	30 000	115 x 39 x 125	Negro	10
85291	10	1 x 50 Hal.	800	100°	● 3000	>80	30 000	115 x 39 x 125	Blanco	10
85292	10	1 x 50 Hal.	800	100°	● 5000	>80	30 000	115 x 39 x 125	Blanco	10
82884	30	1 x 100 Hal.	2 700	100°	● 3000	>80	30 000	150 x 42 x 140	Negro	10
82885	30	1 x 100 Hal.	2 700	100°	● 5000	>80	30 000	150 x 42 x 140	Negro	10
85293	30	1 x 100 Hal.	2 700	100°	● 3000	>80	30 000	150 x 42 x 140	Blanco	10
85294	30	1 x 100 Hal.	2 700	100°	● 5000	>80	30 000	150 x 42 x 140	Blanco	10
82886	50	1 x 100 AM	4 500	100°	● 3000	>80	30 000	180 X 46 X 155	Negro	10
82887	50	1 x 100 AM	4 500	100°	● 5000	>80	30 000	180 X 46 X 155	Negro	10
85295	50	1 x 100 AM	4 500	100°	● 3000	>80	30 000	180 X 46 X 155	Blanco	10
85296	50	1 x 100 AM	4 500	100°	● 5000	>80	30 000	180 X 46 X 155	Blanco	10

\* En sustitución de lámparas de aditivos metálicos / In the replacement of metal halide lamps.



# LEDVANCE® FLOODLIGHT SENSOR

Proyector de LED para iluminación de exteriores con control integrado que permite regular el tiempo de encendido, la distancia de reconocimiento de presencia y la cantidad de brillo que dará de acuerdo a la luz natural del día. Elaborado con materiales de alta calidad, resistente a chorros de agua, lluvia y polvo. Tiene un diseño compacto y moderno, acabado en negro, difusor en vidrio templado esmerilado antirreflejante.

No necesita lámparas complementarias. Disponible en temperatura de color: Luz Cálida (3000 K) y Blanco Frío (5000 K).

LEDVANCE® FLOODLIGHT SENSOR is a LED projector for outdoor lighting, made with high quality materials, resistant to waterjets, rain and dust. It has a compact and modern design, black finish, anti-glare frosted tempered glass diffuser.

No additional lamps needed. Available in Warm Light temperature (3000 K) and Cool Light (5000 K).



 HASTA 80% DE ECONOMÍA <small>SAVES UP TO SAVINGS</small>	 3 AÑOS DE GARANTÍA <small>YEAR WARRANTY</small>	 100 - 240 V~	 IP65	 IK07	 SENSOR DE PRESENCIA <small>PRESENCE SENSOR</small>	 SOPORTE ROTATIVO 180° <small>SWIVEL STAND 180°</small>	 DRIVER INTEGRADO <small>BUILT-IN DRIVER</small>		
--	---	---	---	---	---	---	--	---	---

## APLICACIONES / APPLICATIONS

- |   |   |  |   |  |   |
|---|---|--|---|--|---|
| <br>Jardines<br>Gardens | <br>Entradas principales<br>Main entries | <br>Fachadas<br>Facades | <br>Áreas públicas<br>Public areas | <br>Áreas recreativas<br>Recreative areas | <br>Estacionamientos<br>Parking lots |
|---|---|--|---|--|---|

Código Sku	Potencia Power (W)	Equivalencia Equivalence AM (W)	Flujo Luminoso Luminous Flux (lm)	Ángulo de Apertura Opening Angle	Temp. de Color Color Temp. (K)	IRC CRI	Vida Útil Life (h)	Dimensiones Dimensions (mm)	Color de Producto Product Color	Unidades por Caja Units per box
86418	20	1 x 75	1 800	100°	3000	>80	30 000	167 x 44 x 155	Negro	10
86419	20	1 x 75	1 800	100°	5000	>80	30 000	167 x 44 x 155	Negro	10

\* En sustitución de lámparas de aditivos metálicos / In the replacement of metal halide lamps.



# LEDVANCE® WALL WASHER

Descubra el efecto sorprendente de la luz a través de nuestras luminarias lineales de gran intensidad para destacar detalles, colores y texturas, además de resaltar elementos arquitectónicos con la calidad incomparable de LEDVANCE.

Discover the surprising effect of light through our high intensity linear luminaires to highlight details, colors and textures, as well as highlighting architectural elements with the incomparable quality of LEDVANCE.



**3**  
AÑOS DE GARANTÍA  
YEAR WARRANTY

**24 Vcc**

**IP65**

**DISEÑO COMPACTO**  
COMPACT DESIGN

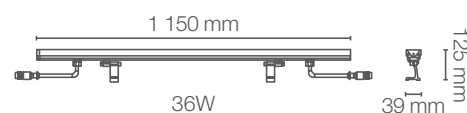

Driver se vende por separado  
Driver sold separately

## APLICACIONES / APPLICATIONS

Museos/Galerías  
Museums/Galleries

Establecimientos  
Shops

Fachadas  
Facades

Código Sku	Potencia Power (W)	Flujo Luminoso Luminous Flux (lm)	Ángulo de Apertura Opening Angle	Temp. de Color Color Temp. (K)	IRC CRI	Vida Útil Life (h)	Dimensiones Dimensions (mm)	Color de Producto Product Color	Unidades por Caja Units per box
86697	36	2340	20 X 45°	3000	>80	30 000	1150 x 39 x 125	Negro	12
86698	36	2340	20 X 45°	5000	>80	30 000	1150 x 39 x 125	Negro	12

## DRIVER



Conectores* Connectors*	Código	Descripción
	80268	Conector 2 metros
	80269	Conector 3 metros
	80270	Conector 5 metros

\* Se venden por separado.

Código Sku	Potencia Power (W)	Tensión de entrada Input Voltage (Vcc)	Tensión de salida Output Voltage (V~)	Vida Útil Life (h)	Capacidad Capacity	Unidades por caja Units per box
86701	320	100-277	24	50 000	8 Wall Washer de 36W	15





# LEDVANCE® AREALIGHT

Luminaria con acabado en aluminio, diseño moderno e índice de protección IP66. Es la mejor opción para iluminar áreas residenciales y exteriores.

Luminaire with aluminum finish, modern design and high index protection. It is the best option to illuminate residential and exterior areas.



**HASTA 50% DE ECONOMÍA**  
SAVES UP TO SAVINGS

**5 AÑOS DE GARANTÍA**  
YEAR WARRANTY

**100 – 240 V~**

**IP 66**

**IK 08**

**10kV**

**30 W**  
Altura recomendada **2-4 m**

**50 W**  
Altura recomendada **4-6 m**

**70 W**  
Altura recomendada **6-8 m**

350.1 mm  
120.3 mm  
48 mm  
**30W**

368.3 mm  
130.3 mm  
48 mm  
**50W**

420 mm  
150.3 mm  
48 mm  
**70W**

## APLICACIONES / APPLICATIONS



Código Sku	Potencia Power (W)	Equivalencia Equivalence AM (W)	Flujo Luminoso Luminous Flux (lm)	Ángulo de Apertura Opening Angle	Temp. de Color Color Temp. (K)	IRC CRI	Vida Útil Life (h)	Dimensiones Dimensions (mm)	Color de Producto Product Color	Unidades por Caja Units per box
86823	30	70	3000	135 x 75°	● 6500	>80	50 000	350.1 x 120.3 x 48	Gris	10
86824	50	100	5000	135 x 75°	● 6500	>80	50 000	368.3 x 130.3 x 48	Gris	10
86825	70	150	7000	135 x 75°	● 6500	>80	50 000	420 x 150.3 x 48	Gris	8
86826	30	70	3000	135 x 75°	○ 4000	>80	50 000	350.1 x 120.3 x 48	Gris	10
86827	50	100	5000	135 x 75°	○ 4000	>80	50 000	368.3 x 130.3 x 48	Gris	10
86828	70	150	7000	135 x 75°	○ 4000	>80	50 000	420 x 150.3 x 48	Gris	8

\* En sustitución de lámparas de aditivos metálicos / In the replacement of metal halide lamps.





**LEDVANCE**

---

# **ALUMBRADO PÚBLICO**





# LEDVANCE® SKY

Luminaria para alumbrado público elaborado con materiales de alta calidad, resistente a la lluvia y al polvo. Tiene un diseño compacto y moderno, acabado en gris. No necesita lámparas complementarias. Disponible en temperatura de color: Blanco Frío (5000 K).

Outdoor lighting luminaire, made with high quality materials, resistant to rain and dust with modern and compact designs. Available in Cool Light (5000 K) temperature.



- HASTA  
50%  
DE  
ECONOMÍA**  
SAVES UP TO  
SAVINGS
- 5**  
AÑOS DE  
GARANTÍA  
YEAR  
WARRANTY
- 90 – 305 V~**
- IP66**
- IK08**
- 10kV**

**incluye adaptador para fotocelda**  
photocell adapter included

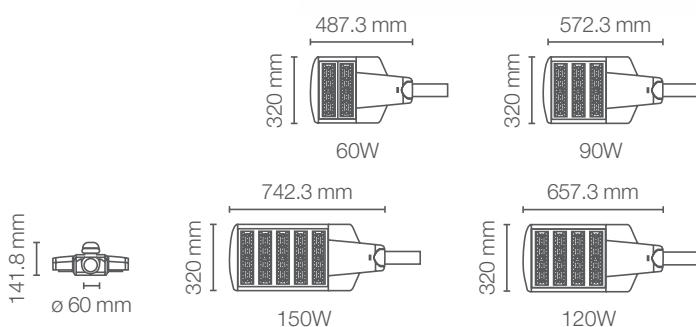

## APLICACIONES / APPLICATIONS



Código Sku	Potencia Power (W)	Equivalencia Equivalence AM (W)	Flujo Luminoso Luminous Flux (lm)	Ángulo de Apertura Opening Angle	Temp. de Color Color Temp. (K)	IRC CRI	Vida Útil Life (h)	Dimensiones Dimensions (mm)	Color de Producto Product Color	Unidades por Caja Units per box
86516	60	100	6600	145°	5000	>80	50 000	487.3 x 320 x 141.8	Gris	1
86425	90	150	9900	145°	5000	>80	50 000	572.3 x 320 x 141.8	Gris	1
86426	120	200	13200	145°	5000	>80	50 000	657.3 x 320 x 141.8	Gris	1
86427	150	250	16500	145°	5000	>80	50 000	742.3 x 320 x 141.8	Gris	1

\* En sustitución de lámparas de aditivos metálicos / In the replacement of metal halide lamps.

# ÍNDICE

## LÁMPARAS DE LED OSRAM

### CLASSIC

LED CLASSIC A19 SUPERSTAR®	62
LED CLASSIC A19 VALUE®	63
LED A19 ATENUABLE SUPERSTAR®	64
LED P45 SUPERSTAR®	65
LED VELAS SUPERSTAR®	66
LED VELAS SUPERSTAR® DIM	67
LED GLOBO SUPERSTAR®	68
LED A19 SENSOR SUPERSTAR®	69
LED CEILING LAMP	70
LED REPELLENT DUAL	71
LED EMERGENCY	72
LED CLASSIC P COLORS	73
LED A19 LEDVANCE SMART+	74
LED CONTROL REMOTO RGBW	75
LED DISCO LAMP RGB	76
LED VINTAGE 1906	77
LED FILAMENT CLASSIC	78
LED FILAMENT SPECIAL	79
LED PIN GLASS G9 SUPERSTAR®	80
LED HIGH WATTAGE SUPERSTAR®	81
LED HIGH WATTAGE ECO	82
LED HIGH WATTAGE E40 SUPERSTAR®	83
LED UFO E40 SUPERSTAR®	84
LED PIN BASE SUPERSTAR®	85



### SPOT

LED AR111 SUPERSTAR®	88
LED SUPERIOR AR111 IRC90	89
LED MR16 SUPERSTAR®	90
LED MR16 VALUE	91
LED PAR16 SUPERSTAR®	92
LED SUPERIOR PAR16 IRC90	93
LED PAR16 RGBW	94
LED PAR16 VALUE	95
LED PAR20 SUPERSTAR®	96
LED PAR20 VALUE	97
LED PAR30 SUPERSTAR®	98
LED PAR30 SUPERSTAR® IP65	99
LED PAR30 HCI SUPERSTAR®	100
LED PAR30 VALUE	101
LED PAR38 SUPERSTAR® IP65	102
LED PAR38 VALUE	103



### TUBOS LED

LED T8 SUPERIOR	106
LED T8 SUPERSTAR®	107
LED T8 SUPERSTAR® SENSOR	108
LED T8 VALUE G2	109
LED T8 ECO	110
LED T8 CURVALUM SUPERSTAR®	111
LED T8 SLIM SUPERSTAR®	112
LED T5 SUPERSTAR®	113







---

# CLASSIC



# LED CLASSIC A19 SUPERSTAR®

Familia de lámparas de LED ideales para iluminación general, disponibles en dos temperaturas de color: Luz Cálida (3000 K) y Luz de Día (6500 K).  
Cuentan con una vida útil de 25 000 horas de vida y multivoltaje (100-240 V~).

LED CLASSIC A19 SUPERSTAR products are suitable for general lighting. Available in two different color temperatures, Warm Light (3000 K) and Day Light (6500 K) possessing up to 25,000 hours life and high voltage range (100-240 V~).



4.5W • 8W • 9.5W

13.5W

HASTA  
**85%**  
DE  
ECONOMÍA

SAVES UP TO  
SAVINGS

**3**  
AÑOS DE  
GARANTÍA

YEAR  
WARRANTY

HASTA  
**25 000h**  
VIDA ÚTIL

PRODUCT  
LIFE

**100 - 240 V~**

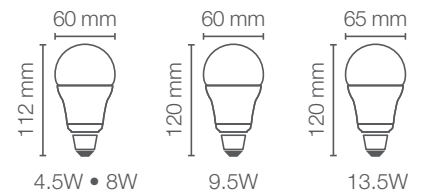

## APLICACIONES / APPLICATIONS



Código Skü	Potencia Power (W)	Equivalencia Equivalence Inc. (W)	Flujo Luminoso Luminous Flux (lm)	IRC CRI	Temp. Color Color Temp. (K)	Vida Útil Life (h)	Acabado Product Finishing	Base Base	Atenuable Dimmable	Dimensiones Dimensions (mm)	Unidades por Caja Units per box
85965	4.5	40	480	>80	3000	25 000	Frosted	E27	No	Ø 60 x 112	12
85966	4.5	40	480	>80	6500	25 000	Frosted	E27	No	Ø 60 x 112	12
85967	8	60	800	>80	3000	25 000	Frosted	E27	No	Ø 60 x 112	12
85968	8	60	800	>80	6500	25 000	Frosted	E27	No	Ø 60 x 112	12
85969	9.5	75	1018	>80	3000	25 000	Frosted	E27	No	Ø 60 x 120	12
85970	9.5	75	1018	>80	6500	25 000	Frosted	E27	No	Ø 60 x 120	12
85971	13.5	100	1521	>80	3000	25 000	Frosted	E27	No	Ø 65 x 120	12
85972	13.5	100	1521	>80	6500	25 000	Frosted	E27	No	Ø 65 x 120	12

\* En sustitución de lámparas incandescentes / Replacing incandescent lamps.



# LED CLASSIC A19 VALUE®

Familia de lámparas de LED ideales para iluminación general, disponibles en dos temperaturas de color: Luz Cálida (3000 K) y Luz de Día (6500 K).  
Cuentan con una vida útil de 10 000 horas y voltaje dedicado (120V~).

LED CLASSIC A19 Value products are suitable for general lighting. Available in two different color temperatures, Warm Light (3000 K) and Day Light (6500 K) possessing up to 10,000 hours life and 120V~ voltage range.



HASTA  
**85%**  
DE  
ECONOMÍA

SAVES UP TO  
SAVINGS

**3**

AÑOS DE  
GARANTÍA

YEAR  
WARRANTY

HASTA  
**10 000h**  
VIDA ÚTIL

PRODUCT  
LIFE

**120 V~**

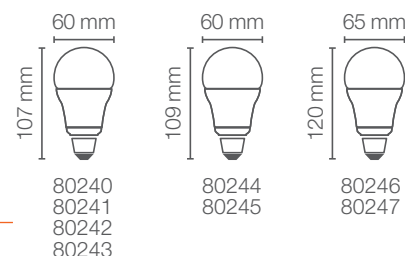

## APLICACIONES / APPLICATIONS



	Código Skü	Potencia Power (W)	Equivalencia Equivalence Inc. (W)	Flujo Luminoso Luminous Flux (lm)	IRC CRI	Temp. Color Color Temp. (K)	Vida Útil Life (h)	Acabado Product Finishing	Base Base	Atenuable Dimmable	Dimensiones Dimensions (mm)	Unidades por Caja Units per box
MTO	80513	5.5	40 W	430	>80	2700	10 000	Perlado	E27	NO	60 x 107	25
	80240	5.5	40 W	450	>80	3000	10 000	Perlado	E27	NO	60 x 107	25
MTO	80514	5.5	40 W	450	>80	4000	10 000	Perlado	E27	NO	60 x 107	25
	80241	5.5	40 W	450	>80	6500	10 000	Perlado	E27	NO	60 x 107	25
MTO	80515	8.5	60 W	800	>80	2700	10 000	Perlado	E27	NO	60 x 107	25
	80242	8.5	60 W	800	>80	3000	10 000	Perlado	E27	NO	60 x 107	25
MTO	80516	8.5	60 W	800	>80	4000	10 000	Perlado	E27	NO	60 x 107	25
	80243	8.5	60 W	800	>80	6500	10 000	Perlado	E27	NO	60 x 107	25
	80244	10	75 W	1000	>80	3000	10 000	Perlado	E27	NO	60 x 109	25
	80245	10	75 W	1000	>80	3000	10 000	Perlado	E27	NO	60 x 109	25
	80246	14	100 W	1500	>80	3000	10 000	Perlado	E27	NO	65 x 120	25
	80247	14	100 W	1500	>80	6500	10 000	Perlado	E27	NO	65 x 120	25

\* En sustitución de lámparas incandescentes / Replacing incandescent lamps.





# LED A19 ATENUABLE SUPERSTAR®

La versión atenuable que permite el control de la intensidad de la luz, creando una atmósfera más acogedora en salas y dormitorios.  
 Uso interior donde se requiera controlar la intensidad de iluminación mediante un dimmer.

The dimmable version is perfect to control the light intensity by a dimmer creating comfort in any room of your spaces. Available in Warm Light (3000 K).



 HASTA <b>86%</b> DE ECONOMÍA  SAVES UP TO SAVINGS	 <b>3</b> AÑOS DE GARANTÍA  YEAR WARRANTY	 HASTA <b>25 000h</b> VIDA ÚTIL  PRODUCT LIFE	 <b>127 V~</b>	 ATENUABLE  DIMMING
---	---	---	-------------------	------------------------------



## APLICACIONES / APPLICATIONS

 Ambientes Residenciales environments	 Recámaras Rooms	 Hoteles Hotels	 Pasillos Corridors	 Establecimientos Shops
--	------------------------	-----------------------	---------------------------	-------------------------------

Código Sku	Potencia Power (W)	Equivalencia Equivalence Inc. (W)	Flujo Luminoso Luminous Flux (lm)	IRC CRI	Temp. Color Color Temp. (K)	Vida Útil Life (h)	Acabado Product Finishing	Base Base	Atenuable Dimmable	Dimensiones Dimensions (mm)	Unidades por Caja Units per box
88131	8.5	60	806	>80	● 3000	25 000	Frosted	E27	Si	60 x 110	12

\* En sustitución de lámparas incandescentes / Replacing incandescent lamps.



## LED P45 SUPERSTAR®

La familia de lámparas P45 son ideales para aplicaciones residenciales que generan un confort de tranquilidad, ideales para lámparas de mesa y luminarias decorativas. Disponibles en 3W con base E12, E14 y E27.

LED P45 SUPERSTAR are perfect for residential application at living room's lamps, giving an unique relaxed comfort. Available in E12, E14 and E27 base.

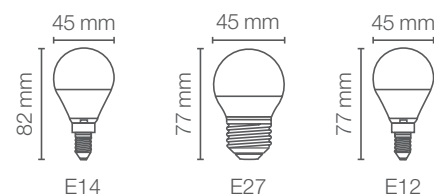

### APLICACIONES / APPLICATIONS

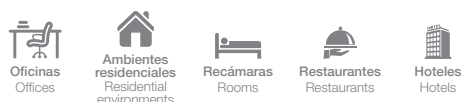

Código Sku	Potencia Power (W)	Equivalencia Inc. (W)	Flujo Luminoso Luminous Flux (lm)	IRC CRI	Temp. Color Color Temp. (K)	Vida Útil Life (h)	Acabado Product Finishing	Base Base	Atenuable Dimmable	Dimensiones Dimensions (mm)	Unidades por Caja Units per box
85961	3	25 W	260	>80	2700	15 000	Frosted	E12	NO	45 x 77	12
85962	3	25 W	260	>80	6500	15 000	Frosted	E12	NO	45 x 77	12
85973	3	25 W	260	>80	2700	15 000	Frosted	E14	NO	45 x 82	12
85974	3	25 W	260	>80	6500	15 000	Frosted	E14	NO	45 x 82	12
85975	3	25 W	260	>80	2700	15 000	Frosted	E27	NO	45 x 77	12
85976	3	25 W	260	>80	6500	15 000	Frosted	E27	NO	45 x 77	12

\* En sustitución de lámparas incandescentes / Replacing incandescent lamps.



## LED VELAS SUPERSTAR®

Las lámparas decorativas tipo vela ofrecen un ahorro de energía comparado con tecnologías tradicionales en versiones no atenuables con base E12 y E27.

The Candles Decorative Types offers energy savings compared with traditional technologies with NO DIM versions with E12 and E27 bases available.



3W E12  
Claro

3W E12

3W E27  
Opalino

3W E27  
Claro

**HASTA  
90%  
DE  
ECONOMÍA**

SAVES UP TO  
SAVINGS

**3**

AÑOS DE  
GARANTÍA

YEAR  
WARRANTY

**HASTA  
15 000h  
VIDA ÚTIL**

**100 - 240 V~**

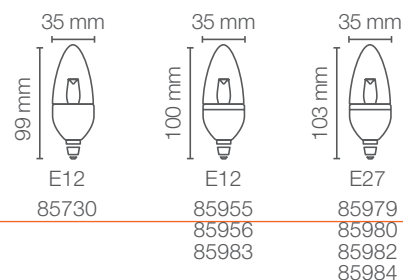

### APLICACIONES / APPLICATIONS



Código Sku	Potencia Power (W)	Equivalencia Inc. (W)	Flujo Luminoso Luminous Flux (lm)	IRC CRI	Temp. Color Color Temp. (K)	Vida Útil Life (h)	Acabado Product Finishing	Base Base	Atenuable Dimmable	Dimensiones Dimensions (mm)	Unidades por Caja Units per box
85955	3	25 W	260	>80	2700	15 000	Frosted	E12	NO	35 x 100	12
85956	3	25 W	260	>80	6500	15 000	Frosted	E12	NO	35 x 100	12
85979	3	25 W	260	>80	2700	15 000	Frosted	E27	NO	35 x 103	12
85980	3	25 W	260	>80	6500	15 000	Frosted	E27	NO	35 x 103	12
85982	3	25 W	260	>80	2700	15 000	Clara	E27	NO	35 x 103	12

\* En sustitución de lámparas incandescentes / Replacing incandescent lamps.





## LED VELAS SUPERSTAR® DIM

Las lámparas decorativas tipo vela ofrecen un ahorro de energía comparado con tecnologías tradicionales en versiones atenuables con base E12, E14 y E27.

The Candles Decorative Types offers energy savings compared with traditional technologies with DIM versions with E12, E14 and E27 bases available.



4W E12 Claro    3W E27 Opalino    3W E27 Claro    4W E14    4W E27

- HASTA 90% DE ECONOMÍA**  
SAVES UP TO SAVINGS
- 3 AÑOS DE GARANTÍA**  
YEAR WARRANTY
- HASTA 15 000h VIDA ÚTIL**
- 127 V~**
- ATENUABLE**  
DIMMING

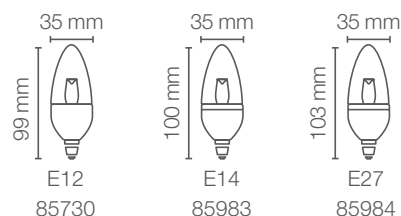

### APLICACIONES / APPLICATIONS



Código Sku	Potencia Power (W)	Equivalencia Inc. (W)	Flujo Luminoso Luminous Flux (lm)	IRC CRI	Temp. Color Color Temp. (K)	Vida Útil Life (h)	Acabado Product Finishing	Base Base	Atenuable Dimmable	Dimensiones Dimensions (mm)	Unidades por Caja Units per box
85983	4	25 W	350	>80	2700	15 000	Claro	E14	SI	35 x 100	12
85984	4	25 W	350	>80	2700	15 000	Claro	E27	SI	35 x 103	12
85730	4	25 W	350	>80	2700	15 000	Claro	E12	SI	35 x 99	12

\* En sustitución de lámparas incandescentes / Replacing incandescent lamps.



# LED GLOBO SUPERSTAR®

Ideal para uso residencial y hotelería. Disponible en temperatura de color: Luz Cálida (2700 K) y Luz de Día (6500 K).

LED GLOBE SUPERSTAR are perfect for hospitality and residential applications. Available in Warm Light (2700 K) and Day Light (6500 K).



**HASTA  
50%  
DE  
ECONOMÍA**

SAVES UP TO  
SAVINGS

**3**

AÑOS DE  
GARANTÍA

YEAR  
WARRANTY

**HASTA  
15 000h  
VIDA ÚTIL**

PRODUCT  
LIFE

**100 – 240 V~**

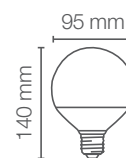

## APLICACIONES / APPLICATIONS

Ambientes  
residenciales  
Residential  
environments

Hoteles  
Hotels

Pasillos  
Corridors

Establecimientos  
Shops

Restaurantes  
Restaurants

Código Sku	Potencia Power (W)	Equivalencia Equivalence Inc. (W)	Flujo Luminoso Luminous Flux (lm)	IRC CRI	Temp. Color Color Temp. (K)	Vida Útil Life (h)	Acabado Product Finishing	Base Base	Atenuable Dimmable	Dimensiones Dimensions (mm)	Unidades por Caja Units per box
86286	9	60	900	>80	● 2 700	15 000	Frosted	E27	NO	95 x 140 mm	12
86287	9	60	900	>80	● 6 500	15 000	Frosted	E27	NO	95 x 140 mm	12

\* En sustitución de lámparas fluorescentes / Replacing fluorescent lamps.



# LED A19 SENSOR SUPERSTAR®

LED A19 SENSOR SUPERSTAR es ideal para iluminar tus espacios sin necesidad de encender la luz cada vez que lo necesites, basta con dejar el apagador encendido. La función de la lámpara es la detección de movimiento a un rango de 3 metros, es capaz de detectar si es de día o de noche para el funcionamiento idóneo de la lámpara. Incluye sensor infrarrojo integrado.

LED A19 SENSOR SUPERSTAR is perfect to light up your spaces without using the switch everytime you need it, just one switch on and the motion sensor will be working to light on/off if it detects some movements from a special range of distance. Available in Warm Light (3000 K) and Day Light (6500 K).



**HASTA 85% DE ECONOMÍA**

SAVES UP TO SAVINGS

**2 AÑOS DE GARANTÍA**

YEAR WARRANTY

**HASTA 25 000h VIDA ÚTIL**

PRODUCT LIFE

**100 - 240 V~**

**E27**

Luz apagada

Luz prendida

360°  
3m  
90°  
6m

60 mm  
119 mm

## APLICACIONES / APPLICATIONS



Código Sku	Potencia Power (W)	Equivalencia Equivalence Inc. (W)	Flujo Luminoso Luminous Flux (lm)	IRC CRI	Temp. Color Color Temp. (K)	Vida Útil Life (h)	Acabado Product Finishing	Base Base	Atenuable Dimmable	Dimensiones Dimensions (mm)	Unidades por Caja Units per box
88152	9	60	806	>80	3 000	25 000	Frosted	E27	NO	60 x 119 mm	12
88153	9	60	806	>80	6 500	25 000	Frosted	E27	NO	60 x 119 mm	12

\* En sustitución de lámparas incandescentes / Replacing incandescent lamps.





## LED CEILING LAMP®

La familia de productos LED CEILING LAMP son idóneos para aplicaciones residenciales con un diseño original y estético con un tamaño ideal para cualquier hogar. Disponible en temperatura: Luz Cálida (3000 K), Blanco Frío (4000 K) y Luz de Día (6500 K) con base E27.

LED CEILING LAMP products are perfect to use in residential applications with an unique and esthetic design and a perfect size to place anywhere. Available in Warm Light (3000 K), Cool Light (4000 K) and Day Light (6500 K) with E27 base.

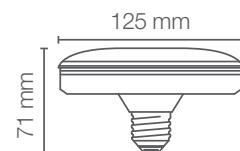

### APLICACIONES / APPLICATIONS



Código Sku	Potencia Power (W)	Equivalencia Equivalence Inc. (W)	Flujo Luminoso Luminous Flux (lm)	IRC CRI	Temp. Color Color Temp. (K)	Vida Útil Life (h)	Acabado Product Finishing	Base Base	Atenuable Dimmable	Dimensiones Dimensions (mm)	Unidades por Caja Units per box
88173	14.5	100	1 300	>80	● 3 000	15 000	Frosted	E27	NO	125 x 71 mm	12
88175	14.5	100	1 400	>80	○ 4 000	15 000	Frosted	E27	NO	125 x 71 mm	12
88176	14.5	100	1 400	>80	● 6 500	15 000	Frosted	E27	NO	125 x 71 mm	12

\* En sustitución de lámparas incandescentes / Replacing incandescent lamps.

OSRAM

# LED REPELLENT DUAL®

Una misma lámpara, dos beneficios. Iluminación general (Luz de Día) y amarillo (Repelente). Cambia de función con cada encendido y apagado. Ideal para zonas húmedas y mucha vegetación.

One lamp, two functions: General lighting at Day Light (6500 K) and repellent mode. Changes the function just with one switch, best option for humidity zones.



- HASTA 87% DE ECONOMÍA**

SAVES UP TO SAVINGS
- 3 AÑOS DE GARANTÍA**

YEAR WARRANTY
- HASTA 25 000h VIDA ÚTIL**

PRODUCT LIFE
- 100 - 240 V~**
- REPELENTE**

REPELLENT

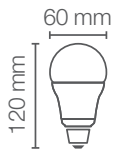

## APLICACIONES / APPLICATIONS

- Ambientes residenciales  
Residential environments
- Hoteles  
Hotels
- Establecimientos  
Shops
- Jardines  
Gardens
- Pasillos  
Corridors

Use exterior solo con luminarios.

Código Sku	Potencia Power (W)	Equivalencia Equivalence Inc. (W)	Flujo Luminoso Luminous Flux (lm)	IRC CRI	Temp. Color Color Temp. (K)	Vida Útil Life (h)	Acabado Product Finishing	Base Base	Atenuable Dimmable	Dimensiones Dimensions (mm)	Unidades por Caja Units per box
88067	8	60	806	>80	<span style="color: green;">●</span> 6500 + <span style="color: blue;">●</span> Luz amarilla (Repelente)	25 000	Frosted	E27	NO	60 x 120 mm	12

\* En sustitución de lámparas incandescentes / Replacing incandescent lamps.



# LED EMERGENCY

La lámpara de emergencia asegura la iluminación en todo momento, ya que funciona como un bulbo normal y gracias a su batería integrada, cambia a modo emergencia de forma automática cuando haya una interrupción en la energía eléctrica (hasta 2.5 hrs)

The lamp has two working modes, it works as a common light bulb and it swith to emergency mode after power shut down automatically (2.5 hrs)



**HASTA  
87%  
DE  
ECONOMÍA**

SAVES UP TO  
SAVINGS

**2**

AÑOS DE  
GARANTÍA

YEAR  
WARRANTY

**HASTA  
15 000h  
VIDA ÚTIL**

PRODUCT  
LIFE

**100 – 240 V ~**

**Batería de  
litio  
integrada**

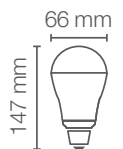

## APLICACIONES / APPLICATIONS

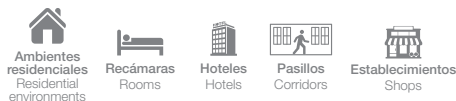

Código Sku	Potencia Power (W)	Equivalencia Equivalence Inc. (W)	Flujo Luminoso Luminous Flux (lm)	IRC CRI	Temp. Color Color Temp. (K)	Vida Útil Life (h)	Acabado Product Finishing	Base Base	Atenuable Dimmable	Dimensiones Dimensions (mm)	Unidades por Caja Units per box
80107	10	60	806	>80	● 3 000	15 000	Frosted	E27	NO	66 x 147 mm	12
80108	10	60	850	>80	● 6 500	15 000	Frosted	E27	NO	66 x 147 mm	12





# LED CLASSIC P COLORS

La familia de lámparas CLASSIC P COLORS son ideales para aplicaciones decorativas en cuatro colores distintos que generan un ambiente único

The CLASSIC P COLORS family are ideal for decorative applications in four different colors that create a unique atmosphere



HASTA  
**85%**  
DE  
ECONOMÍA

SAVES UP TO  
SAVINGS

**3**  
AÑOS DE  
GARANTÍA

YEAR  
WARRANTY

HASTA  
**15 000h**  
VIDA ÚTIL

PRODUCT  
LIFE

100 – 240 V ~

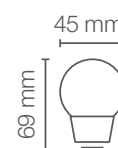

## APLICACIONES / APPLICATIONS



Código Sku	Potencia Power (W)	Equivalencia Inc. (W)	IRC CRI	Temp. Color Color Temp. (K)	Vida Útil Life (h)	Base Base	Atenuable Dimmable	Dimensiones Dimensions (mm)	Unidades por Caja Units per box
80226	1.2	25	>80	Verde	15 000	E27	NO	Ø 45 x 69 mm	12
80227	1.2	25	>80	Amarillo	15 000	E27	NO	Ø 45 x 69 mm	12
80228	1.2	25	>80	Rojo	15 000	E27	NO	Ø 45 x 69 mm	12
80229	1.2	25	>80	Azul	15 000	E27	NO	Ø 45 x 69 mm	12



# LED A19 LEDVANCE SMART+®

Conexión vía Bluetooth Mesh Network (Disponible para Android y iOS). Cuenta con dos tipos de iluminación: Iluminación general (2700 K a 6500 K) o Iluminación decorativa (RGB). Puede ser usada mediante comandos de voz (Siri y Google). Control de la intensidad de color mediante aplicación.

Connected and controlled by Bluetooth, available for Android and iOS. It can be switched to different colors (RGBW), change the color temperature (2700 K to 6500 K) and it can be dimmable from 0% to 100% creating scenes for each ambient you want to control. Also it can be managed by voice commands from Google and Siri.



- HASTA 85% DE ECONOMÍA**  
SAVES UP TO SAVINGS
- 2 AÑOS DE GARANTÍA**  
YEAR WARRANTY
- HASTA 15 000h VIDA ÚTIL**  
PRODUCT LIFE
- 127 V~**
- ATENUABLE**  
DIMMING
- CONTROL VIA IOS / ANDROID**
- COLOR RGBW**



## APLICACIONES / APPLICATIONS

- Ambientes residenciales**  
Residential environments
- Hoteles**  
Hotels
- Establecimientos**  
Shops
- Restaurantes/Bares**  
Restaurants/Bars
- Salas**  
Living rooms
- Recámaras**  
Rooms



Código Sku	Potencia Power (W)	Equivalencia Equivalence Inc. (W)	Flujo Luminoso Luminous Flux (lm)	IRC CRI	Temp. Color Color Temp. (K)	Vida Útil Life (h)	Acabado Product Finishing	Base Base	Atenuable Dimmable	Dimensiones Dimensions (mm)	Unidades por Caja Units per box
88112	10	60	800	>80	RGBW	15 000	Frosted	E27	Si	60 x 120 mm	4

\* En sustitución de lámparas incandescentes / Replacing incandescent lamps.



# LED CONTROL REMOTO RGBW®

La familia LED RGBW es un sistema de iluminación controlado vía control remoto que cuenta con control de intensidad y cambio de colores, personaliza tus ambientes con un estilo único con control de atenuación.

LED RGBW REMOTE CONTROL products are a special illumination system controlled by infrared remote control with dimmable controls and change of some colors to personalize your spaces with an unique style with dimming control.



7.5W

**3**  
AÑOS DE GARANTÍA  
YEAR WARRANTY

HASTA **15 000h**  
VIDA ÚTIL  
PRODUCT LIFE

**100 – 240 V~**

**ATENUABLE**  
DIMMING

**COLOR RGBW**

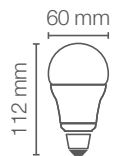

## APLICACIONES / APPLICATIONS

**Salas**  
Living rooms

**Recámaras**  
Rooms

**Áreas Gastronómicas**  
Gastronomic areas

**Hoteles**  
Hotels

**Restaurantes/Bares**  
Restaurants/Bars

Código Sku	Potencia Power (W)	Equivalencia Equivalence Inc. (W)	Flujo Luminoso Luminous Flux (lm)	IRC CRI	Temp. Color Color Temp. (K)	Vida Útil Life (h)	Acabado Product Finishing	Base Base	Atenuable Dimmable	Dimensiones Dimensions (mm)	Unidades por Caja Units per box
86277	7.5	60	600	>80	RGBW	15 000	Frosted	E27	SI	60 x 112 mm	12

\* En sustitución de lámparas incandescentes / Replacing incandescent lamps.

\*\* Atenuable únicamente mediante control remoto (incluido) / Dimmable only by remote control (included).





# LED DISCO RGB®

La lámpara DISCO RGB cuenta con un bulbo giratorio que al encenderlo comienza a girar con cambio de colores nítidos que ofrecerá un ambiente único. ¡Ideales para tus fiestas!

LED Disco RGB has a rotating bulb to get the party started with colors mix with vivid colors that will give you an unique scene for your holidays!



**2**  
AÑOS DE GARANTÍA  
YEAR WARRANTY

HASTA **6 000h**  
VIDA ÚTIL  
PRODUCT LIFE

**120 V~**

**COLOR RGBW**

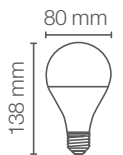

## APLICACIONES / APPLICATIONS

**Ambientes residenciales**  
Residential environments

**Hoteles**  
Hotels

**Restaurants**  
Restaurants

Código Sku	Potencia Power (W)	Equivalencia Inc. (W)	IRC CRI	Temp. Color Color Temp. (K)	Vida Útil Life (h)	Base Base	Atenuable Dimmable	Dimensiones Dimensions (mm)	Unidades por Caja Units per box
87893	5	25	>80	RGBW	6 000	E27	NO	80 x 138 mm	6

\* En sustitución de lámparas incandescentes / Replacing incandescent lamps.



# LED VINTAGE® 1906

Lámparas de estilo vintage para decorar tus espacios con estilos inigualables y con un ahorro de energía de hasta 90% comparado con tecnologías tradicionales, disponibles en base E27 con acabado ambar en temperatura Luz Cálida (2500 K).

LED VINTAGE 1906 are perfect to decorate your lighting spaces with incomparable styles, saving energy up to 90% vs. traditional technologies. Available in E27 base with ambar finish in Warm Light (2500 K).



LED FIL  
CLA B 2.5

LED FIL  
CLA B 4.5

LED FIL CLA60

**HASTA 90% DE ECONOMÍA**  
SAVES UP TO SAVINGS

**3 AÑOS DE GARANTÍA**  
YEAR WARRANTY

**HASTA 20 000h VIDA ÚTIL**  
PRODUCT LIFE

**127 V~**

**LED FILAMENTO**  
LED FILAMENT

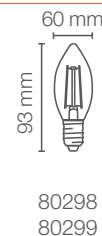

80298  
80299



80296

## APLICACIONES / APPLICATIONS



Código Sku	Potencia Power (W)	Equivalencia Inc. (W)	Flujo Luminoso Luminous Flux (lm)	IRC CRI	Temp. Color Color Temp. (K)	Vida Útil Life (h)	Acabado Product Finishing	Base Base	Atenuable Dimmable	Dimensiones Dimensions (mm)	Unidades por Caja Units per box
80296	7	60 W	725	>80	● 2 500	20 000	Ambar	E27	NO	60 x 104	12
80298	2.5	25 W	225	>80	● 2 500	20 000	Ambar	E27	NO	60 x 93	12
80299	4.5	40 W	420	>80	● 2 500	20 000	Ambar	E27	NO	60 x 93	12

\* En sustitución de lámparas incandescentes / Replacing incandescent lamps.



# LED FILAMENT CLASSIC

La familia de lámparas LED FILAMENT son ideales para aplicaciones decorativas, donde se quiera dar un toque único en los espacios, creando ambientes de confort y tranquilidad

The family of LED FILAMENT lamps are ideal for decorative applications, where you want to give a unique touch in the spaces, creating environments of comfort and tranquility



- HASTA 90% DE ECONOMÍA**

SAVES UP TO SAVINGS
- 3 AÑOS DE GARANTÍA**

YEAR WARRANTY
- HASTA 25 000h VIDA ÚTIL**

PRODUCT LIFE
- 100-240 V~**
- LED FILAMENTO**

LED FILAMENT
- ENERGY STAR 19%

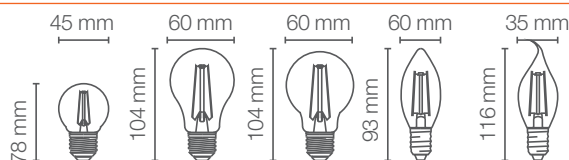

## APLICACIONES / APPLICATIONS



Código Sku	Potencia Power (W)	Equivalencia Inc. (W)	Flujo Luminoso Luminous Flux (lm)	IRC CRI	Temp. Color Color Temp. (K)	Vida Útil Life (h)	Acabado Product Finishing	Tipo de bulbo Bulb	Base Base	Dimensiones Dimensions (mm)	Unidades por Caja Units per box
80278	2.5	25 W	250	>80	2 700	15 000	Clear	B10	E27	60 x 93	12
80284	2.5	25 W	250	>80	2 700	15 000	Frosted	B10	E27	60 x 93	12
80279	2.5	25 W	250	>80	2 700	15 000	Clear	CA10	E27	116 x 35	12
80285	2.5	25 W	250	>80	2 700	15 000	Frosted	CA10	E27	116 x 35	12
80280	2.5	25 W	250	>80	2 700	15 000	Clear	P45	E27	78 x 45	12
80286	2.5	25 W	250	>80	2 700	15 000	Frosted	P45	E27	78 x 45	12
80281	4.5	40 W	470	>80	2 700	25 000	Clear	A19	E27	60 x 104	12
80282	7	60 W	806	>80	2 700	25 000	Clear	A19	E27	60 x 104	12
80287	4.5	40 W	470	>80	2 700	25 000	Frosted	A19	E27	60 x 104	12
80288	7	60 W	806	>80	2 700	25 000	Frosted	A19	E27	60 x 104	12
80283	4.5	40 W	470	>80	2 700	15 000	Clear	G95	E27	95 x 140	6
80289	4.5	40 W	470	>80	2 700	15 000	Frosted	G95	E27	95 x 140	6

\* En sustitución de lámparas incandescentes / Replacing incandescent lamps.





# LED FILAMENT SPECIAL

La familia de lámparas LED FILAMENT son ideales para aplicaciones decorativas, donde se quiera dar un toque especial, gracias a sus diseños únicos, creando ambientes de confort y tranquilidad

The family of LED FILAMENT lamps are ideal for decorative applications, where you want to give a special touch thanks to their unique designs, creating environments of comfort and tranquility



HASTA  
**90%**  
DE  
ECONOMÍA

SAVES UP TO  
SAVINGS

**2**  
AÑOS DE  
GARANTÍA

YEAR  
WARRANTY

HASTA  
**15 000h**  
VIDA ÚTIL

PRODUCT  
LIFE

**100-240 V~**

**LED  
FILAMENTO**

LED  
FILAMENT

193 mm, 200 mm, 120 mm, 164 mm, 32 mm, 65 mm, 425 mm, 283 mm, 122 mm, 330 mm, 185 mm, 270 mm

## APLICACIONES / APPLICATIONS



Código Sku	Potencia Power (W)	Equivalencia Inc. (W)	Flujo Luminoso Luminous Flux (lm)	IRC CRI	Temp. Color Color Temp. (K)	Vida Útil Life (h)	Acabado Product Finishing	Tipo de bulbo Bulb	Base Base	Dimensiones Dimensions (mm)	Unidades por Caja Units per box
80290	5	25 W	90	>80	● 1 800	15 000	Negro	NO DEFINIDO	E27	425X193	2
80291	5	25 W	250	>80	○ 4 000	15 000	Negro	G200	E27	283 x 200	2
80292	5	25 W	350	>80	● 2 000	15 000	Ambar	ST164	E27	300 x 164	2
80293	5	25 W	350	>80	● 2 000	15 000	Ambar	T65	E27	270 x 65	4
80294	2	25 W	225	>80	● 2 500	15 000	Ambar	M120	E27	122 x 12	5
80295	5	25 W	250	>80	● 2 000	15 000	Ambar	T32	E27	185 x 32	12

\* En sustitución de lámparas incandescentes / Replacing incandescent lamps.



# LED PIN GLASS G9 SUPERSTAR®

Producto compacto que se adapta a diferentes tipos de luminarias. Brinda una mejor distribución de luz y hasta 90% de ahorro en energía.

Ideal product to fit in so many luminaries. It gives an energy saving up to 90% and an optimal light distribution. Available in Warm Light (2500 K).



**HASTA  
90%  
DE  
ECONOMÍA**

SAVES UP TO  
SAVINGS

**3**

AÑOS DE  
GARANTÍA

YEAR  
WARRANTY

**HASTA  
10 000h  
VIDA ÚTIL**

PRODUCT  
LIFE

**127 V~**

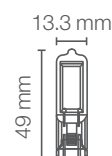

## APLICACIONES / APPLICATIONS

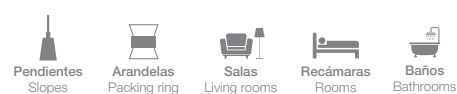

Código Sku	Potencia Power (W)	Equivalencia Equivalence Inc. (W)	Flujo Luminoso Luminous Flux (lm)	IRC CRI	Temp. Color Color Temp. (K)	Vida Útil Life (h)	Acabado Product Finishing	Base Base	Atenuable Dimmable	Dimensiones Dimensions (mm)	Unidades por Caja Units per box
85818	2	20 W	200	>80	● 2 500	10 000	Clear	G9	NO	13.3 X 49	12

\* En sustitución de lámparas halógenas / Replacing halogen lamps.



# LED HIGH WATTAGE SUPERSTAR®

La familia de LED Alta Potencia con base E27 son una excelente solución para la sustitución de lámparas fluorescentes ahorradoras compactas, ideales para aplicaciones residenciales y comerciales.

LED HIGH WATTAGE SUPERSTAR products are suitable for residential and commercial applications, replacing high wattage compact fluorescent lamps up to 80W. Direct replacement with E27 base.



**HASTA  
50%  
DE  
ECONOMÍA**

SAVES UP TO  
SAVINGS

**3**

AÑOS DE  
GARANTÍA

YEAR  
WARRANTY

HASTA  
**25 000h**  
VIDA ÚTIL

PRODUCT  
LIFE

**100-240 V~**

ALTO FLUJO  
LUMINOSO

HIGH LUMINOUS  
FLOW

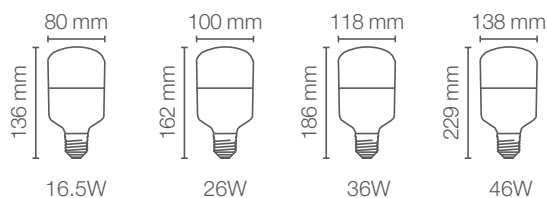

## APLICACIONES / APPLICATIONS



Código Sku	Potencia Power (W)	Equivalencia Equivalence CFLi. (W)	Flujo Luminoso Luminous Flux (lm)	IRC CRI	Temp. Color Color Temp. (K)	Vida Útil Life (h)	Acabado Product Finishing	Base Base	Atenuable Dimmable	Dimensiones Dimensions (mm)	Unidades por Caja Units per box
85824	16.5 W	30	1 800	>80	● 6 500	25 000	Frosted	E27	NO	Ø 80 X 136	12
85825	26 W	45	2 800	>80	● 6 500	25 000	Frosted	E27	NO	Ø 100 X 162	12
85826	36 W	65	3 800	>80	● 6 500	25 000	Frosted	E27	NO	Ø 118 X 186	6
85827	46 W	80	4 850	>80	● 6 500	25 000	Frosted	E27	NO	Ø 138 X 229	6

\* En sustitución de lámparas incandescentes / Replacing incandescent lamps.





# LED HIGH WATTAGE ECO

La familia de LED ALTA POTENCIA ECO con base E27 son una excelente sustitución de lámparas fluorescentes ahorradoras compactas, ofreciendo una solución funcional a tu alcance.

The ECO HIGH POWER LED family with E27 base are an excellent replacement for compact energy saving fluorescent lamps, offering a functional solution at your fingertips.



**HASTA 50% DE ECONOMÍA**

SAVES UP TO SAVINGS

**3 AÑOS DE GARANTÍA**

YEAR WARRANTY

**HASTA 10 000h VIDA ÚTIL**

PRODUCT LIFE

**120 V~**

**ALTO FLUJO LUMINOSO**

HIGH LUMINOUS FLOW

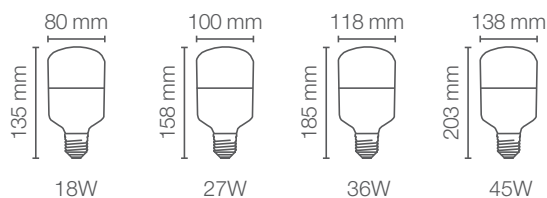

## APLICACIONES / APPLICATIONS



Código Sku	Potencia Power (W)	Equivalencia Equivalence CFLi. (W)	Flujo Luminoso Luminous Flux (lm)	IRC CRI	Temp. Color Color Temp. (K)	Vida Útil Life (h)	Acabado Product Finishing	Base Base	Atenuable Dimmable	Dimensiones Dimensions (mm)	Unidades por Caja Units per box
80579	18	30	1 800	>80	● 6 500	10 000	Frosted	E27	NO	Ø 135 x 80	8
80580	27	45	2 800	>80	● 6 500	10 000	Frosted	E27	NO	Ø 158 x 100	8
80581	36	65	3 800	>80	● 6 500	10 000	Frosted	E27	NO	Ø 185 x 118	8
80582	45	80	4 850	>80	● 6 500	10 000	Frosted	E27	NO	Ø 203 x 138	8

\* En sustitución de lámparas incandescentes / Replacing incandescent lamps.



# LED HIGH WATTAGE E40 SUPERSTAR®

La familia de lámparas de altas potencias con base E40 son ideales para bodegas, almacenes, establecimientos o aplicaciones industriales para sustituir lámparas de aditivo metálico y ahorrar hasta 50% en el consumo eléctrico. Disponibles en base mogúl (E40) y voltaje hasta 100-277 V~. Solo para interiores.

LED HIGH WATTAGE E40 SUPERSTAR are perfect for indoor industrial applications replacing traditional technologies like mercury or sodium lamps saving energy up to 50% and high voltage range (100-277 V~).



**HASTA  
63%  
DE  
ECONOMÍA**

SAVES UP TO  
SAVINGS

**3**

AÑOS DE  
GARANTÍA

YEAR  
WARRANTY

HASTA  
**25 000h**  
VIDA ÚTIL

PRODUCT  
LIFE

**100 - 277 V~**



ALTO FLUJO  
LUMINOSO

HIGH LUMINOUS  
FLOW



## APLICACIONES / APPLICATIONS



Código Sku	Potencia Power (W)	Equivalencia Equivalence CFLi. (W)	Flujo Luminoso Luminous Flux (lm)	IRC CRI	Temp. Color Color Temp. (K)	Vida Útil Life (h)	Acabado Product Finishing	Base Base	Atenuable Dimmable	Dimensiones Dimensions (mm)	Unidades por Caja Units per box
86293	65	100	5 800	>80	● 6 500	25 000	Frosted	E40	NO	145 X 217	4
86294	80	125	7 800	>80	● 6 500	25 000	Frosted	E40	NO	170 X 229	4
86295	100	175	9 500	>80	● 6 500	25 000	Frosted	E40	NO	190 X 270	2
86296	120	250	12 000	>80	● 6 500	25 000	Frosted	E40	NO	190 X 270	2

\* En sustitución de lámparas incandescentes / Replacing incandescent lamps.





## LED UFO E40 SUPERSTAR®

Alto flujo luminoso, sustitución de lámparas tradicionales como lámparas de mercurio hasta 250 W. Altura de montaje recomendable hasta 8 metros. Bajo consumo de energía. Base Mogúl (E40).

High luminous flux, perfect replacement for traditional technologies up to 250W. Ideal mounting height is up to 8 meters with energy saving up to 70% and high CRI >80.



- HASTA  
70%  
DE  
ECONOMÍA

SAVES UP TO  
SAVINGS
- 3  
AÑOS DE  
GARANTÍA

YEAR  
WARRANTY
- HASTA  
25 000h  
VIDA ÚTIL

PRODUCT  
LIFE
- 100 - 277 V~
- ALTO FLUJO  
LUMINOSO

HIGH LUMINOUS  
FLOW

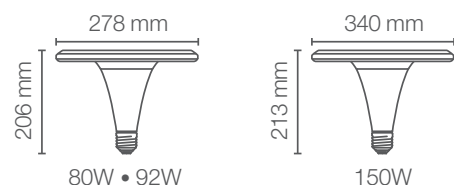

### APLICACIONES / APPLICATIONS



Código Sku	Potencia Power (W)	Equivalencia Equivalence Inc. (W)	Flujo Luminoso Luminous Flux (lm)	IRC CRI	Temp. Color Color Temp. (K)	Vida Útil Life (h)	Base Base	Atenuable Dimmable	Dimensiones Dimensions (mm)	Unidades por Caja Units per box
88149	80	175	8 500	>80	● 6 500	25 000	E40	NO	278 x 206	2
88150	92	250	12 000	>80	● 6 500	25 000	E40	NO	278 x 206	2
88151	150	400	18 000	>80	● 6 500	25 000	E40	NO	340 x 213	2

\* En sustitución de lámparas de aditivo metálico. / Replacing metal halide lamps.



# LED PIN BASE SUPERSTAR®

Las lámparas LED PIN BASE SUPERSTAR son ideales para aplicaciones comerciales, brindando un ahorro de energía de hasta 50% con una vida útil de 30 000 horas de vida garantizando años de servicio y reducción de costos de mantenimiento. Es el perfecto sustituto de lámparas fluorescentes pin base con base G24Q, 2G11, G23 y 2G7. Driver integrado con rango de voltaje de 120-277 V~.

LED PIN BASE SUPERSTAR are perfect for commercial applications, offering an energy saving up to 50% with 30 000 hours life guarantying years of service and maintenance saving costs. Perfect replacement for fluorescent pin base lamps with G24Q, 2G11, G23 and 2G7 base.

No external ballast or driver needed. Voltage range of 120-277 V~.



**HASTA 50% DE ECONOMÍA**

SAVES UP TO SAVINGS

**3 AÑOS DE GARANTÍA**

YEAR WARRANTY

**HASTA 30 000h VIDA ÚTIL**

PRODUCT LIFE

**120 - 277 V~**

**2700K**

**4000K**

**6500K**

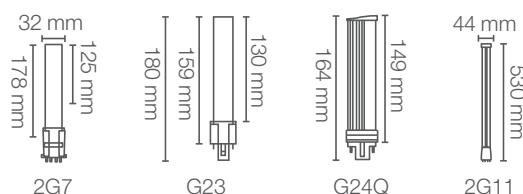

## APLICACIONES / APPLICATIONS



Código Sku	Potencia Power (W)	Equivalencia Equivalence Inc. (W)	Flujo Luminoso Luminous Flux (lm)	IRC CRI	Temp. Color Color Temp. (K)	Vida Útil Life (h)	Acabado Product Finishing	Base Base	Atenuable Dimmable	Dimensiones Dimensions (mm)	Unidades por Caja Units per box
85191	6	13 (Dulux S)	490	>80	● 2 700	30 000	Frosted	G23	No	159 x 130 x 180	20
85192	6	13 (Dulux S)	540	>80	○ 4 000	30 000	Frosted	G23	No	159 x 130 x 180	20
85193	6	13 (Dulux S)	540	>80	● 6 500	30 000	Frosted	G23	No	159 x 130 x 180	20
85194	6	13 (Dulux SE)	490	>80	● 2 700	30 000	Frosted	2G7	No	125 x 32 x 178	20
85195	6	13 (Dulux SE)	540	>80	○ 4 000	30 000	Frosted	2G7	No	125 x 32 x 178	20
80113	6	13 (Dulux SE)	540	>80	● 6 500	30 000	Frosted	2G7	No	125 x 32 x 178	20
80114	17	40 (Dulux L)	2000	>80	● 2 700	30 000	Frosted	2G11	No	44 x 530	30
80115	17	40 (Dulux L)	2200	>80	○ 4 000	30 000	Frosted	2G11	No	44 x 530	30
80116	17	40 (Dulux L)	2200	>80	● 6 500	30 000	Frosted	2G11	No	44 x 530	30
80117	8	26 (Dulux DE)	720	>80	● 2 700	30 000	Frosted	G24Q	No	164 x 149	50
80118	8	26 (Dulux DE)	800	>80	○ 4 000	30 000	Frosted	G24Q	No	164 x 149	50
80119	8	26 (Dulux DE)	800	>80	● 6 500	30 000	Frosted	G24Q	No	164 x 149	50

\* En sustitución de lámparas fluorescentes / Replacing fluorescent lamps.





---

# SPOT



## LED AR111 SUPERSTAR®

Las lámparas de LED AR111 SUPERSTAR cuentan con un diseño tradicional de halógeno con tecnología innovadora. Cuentan con driver integrado con un rango de voltaje de 100-240 V~. Disponibles en base G53 y GU10 con 24° y 40°, además con opción no atenuable y atenuable.

\*Ideales para luminarias LEDVANCE Tracklight y LEDVANCE Multispot.



TRACKLIGHT



MULTISPOT



LED AR111 SUPERSTAR products have a traditional halogen design with new LED technology. Does not need any external ballast or driver to operate. Voltage range of 100-240 V~. Available at G53 and GU10 base with 24° and 40°, additionally with dimmable and not dimmable version.

\*Ideal for LEDVANCE Tracklight and LEDVANCE Multispot Luminaires.

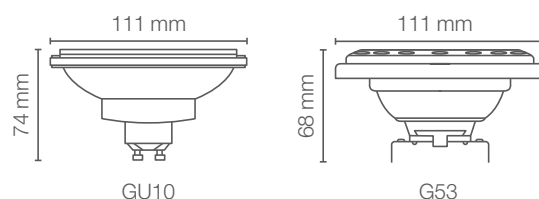
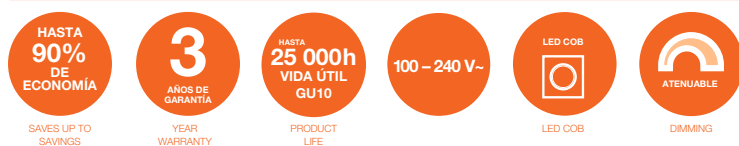

### APLICACIONES / APPLICATIONS



Código Sku	Potencia Power (W)	Equivalencia Equivalence Halógena (W)	Flujo Luminoso Luminous Flux (lm)	Ángulo de Apertura Opening Angle	IRC CRI	Temp. Color Color Temp. (K)	Vida Útil Life (h)	Base Base	Atenuable Dimmable	Dimensiones Dimensions (mm)	Unidades por Caja Units per box
86354	12	75	950	24°	>80	2 700	25 000	GU10	No	111 x 74	12
86355	12	75	950	24°	>80	2 700	25 000	GU10	Si	111 x 74	12
86356	12	75	950	40°	>80	2 700	25 000	GU10	Si	111 x 74	12
86357	12	75	950	40°	>80	2 700	25 000	G53	Si	111 x 68	12

\* En sustitución de lámparas halógenas / Replacing halogen lamps.





# LED SUPERIOR AR111 IRC90

La lámparas AR111 aseguran una iluminación profesional, debido a su alto IRC (90%), ideal para boutiques, showrooms, galerías, museos, etc. donde se requiera una alta fidelidad de color

\*Ideales para luminarias LEDVANCE Tracklight y LEDVANCE Multispot.



TRACKLIGHT



MULTISPOT



The AR111 lamps ensure professional lighting, due to its high IRC (90%), ideal for boutiques, showrooms, galleries, museums, etc. where high color fidelity is required

\*Ideal for LEDVANCE Tracklight and LEDVANCE Multispot Luminaires.

**HASTA  
90%  
DE  
ECONOMÍA**

SAVES UP TO  
SAVINGS

**3**

AÑOS DE  
GARANTÍA

YEAR  
WARRANTY

**HASTA  
25 000h  
VIDA ÚTIL  
GU10**

PRODUCT  
LIFE

**100 - 277 V~**

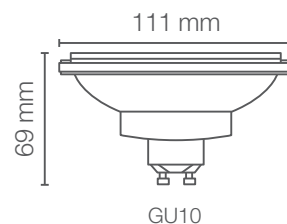

## APLICACIONES / APPLICATIONS



Código Sku	Potencia Power (W)	Equivalencia Equivalence Halógena (W)	Flujo Luminoso Luminous Flux (lm)	Ángulo de Apertura Opening Angle	IRC CRI	Temp. Color Color Temp. (K)	Vida Útil Life (h)	Base Base	Atenuable Dimmable	Dimensiones Dimensions (mm)	Unidades por Caja Units per box
80176	10	75	750	12°	>90	● 2 700	25 000	GU10	No	111 x 69	12
80177	10	75	750	24°	>90	● 2 700	25 000	GU10	No	111 x 69	12

\* En sustitución de lámparas halógenas / Replacing halogen lamps.



## LED MR16 SUPERSTAR®

La familia LED MR16 Superstar son ideales para iluminación de acento en aplicaciones residenciales y comerciales, disponibles en temperatura: Luz Cálida (3000 K).  
Reemplazan a la tecnología de halógeno de 75W.

LED MR16 SUPERSTAR products are perfect for accent lighting at residential and hospitality applications Available in Warm Light (3000 K). Perfect halogen replacement of 75W.

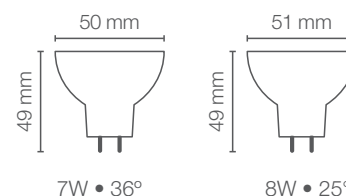

### APLICACIONES / APPLICATIONS



Código Sku	Potencia Power (W)	Equivalencia Equivalence Halógena (W)	Flujo Luminoso Luminous Flux (lm)	Ángulo de Apertura Opening Angle	IRC CRI	Temp. Color Color Temp. (K)	Vida Útil Life (h)	Base Base	Atenuable Dimmable	Dimensiones Dimensions (mm)	Unidades por Caja Units per box
87957	7	50	500	36°	>90	● 3 000	25 000	GU5.3	Si	50 x 49	6
87956	8	75	700	25°	>80	● 3 000	25 000	GU5.3	Si	51 x 49	6

\* En sustitución de lámparas halógenas / Replacing halogen lamps.



## LED MR16 VALUE®

La familia LED MR16 Value son ideales para iluminación de acento en aplicaciones residenciales y comerciales, disponibles en temperatura: Luz Cálida (2700 K), (3000 K), Luz Neutra (4000 K) y Luz de Día (6500 K). Reemplazan a la tecnología de halógeno de 50 W. ¡Incluye porta lámpara para evitar accidentes!

LED MR16 VALUE products are perfect for accent lighting at residential and hospitality applications. Available in Temperatures (2700 K), (3000 K), (4000 K) and (6500 K). Includes lamp holder to avoid accidents!



- HASTA 85% DE ECONOMÍA**  
SAVES UP TO SAVINGS
- 3 AÑOS DE GARANTÍA**  
YEAR WARRANTY
- HASTA 15 000h VIDA ÚTIL**  
PRODUCT LIFE
- 100 - 240 V~**

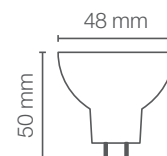

### APLICACIONES / APPLICATIONS



Código Sku	Potencia Power (W)	Equivalencia Equivalence Halógena (W)	Flujo Luminoso Luminous Flux (lm)	Ángulo de Apertura Opening Angle	IRC CRI	Temp. Color Color Temp. (K)	Vida Útil Life (h)	Base Base	Atenuable Dimmable	Dimensiones Dimensions (mm)	Unidades por Caja Units per box
85987	5	50	400	36°	>80	● 2 700	15 000	GU5.3	No	50 x 48	12
85886	5	50	400	36°	>80	● 3 000	15 000	GU5.3	No	50 x 48	12
85988	5	50	400	36°	>80	○ 4 000	15 000	GU5.3	No	50 x 48	12
85897	5	50	450	36°	>80	● 6 500	15 000	GU5.3	No	50 x 48	12

\* En sustitución de lámparas halógenas / Replacing halogen lamps.





## LED PAR16 SUPERSTAR®

Las lámparas PAR16 SUPERSTAR son ideales para destacar objetos (cuadros, esculturas, rasgos arquitectónicos, etc) y lugares (baños de luz en las paredes y la luz de teatro).

LED PAR16 SUPERSTAR lamps are ideal for highlighting objects (paintings, sculptures, architectural features, etc) and places (light baths on the walls and theater light). Available in dimmable version.



SAVES UP TO 90% SAVINGS



YEAR WARRANTY



PRODUCT LIFE



85820 84499



80476



80480 80481



DIMMING

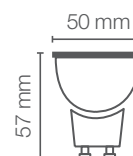

80476

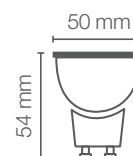

80474,80475 80480,80481

### APLICACIONES / APPLICATIONS



Código Sku	Potencia Power (W)	Equivalencia Equivalence Halógena (W)	Voltaje Voltage (V)	Flujo Luminoso Luminous Flux (lm)	Ángulo de Apertura Opening Angle	IRC CRI	Temp. Color Color Temp. (K)	Vida Util Life (h)	Base Base	Atenuable Dimmable	Dimensiones Dimensions (mm)	Unidades por Caja Units per box
85820	5	50	120	350	35°	>80	2 700	25 000	GU10	Si	49 x 55	6
84499	6	60	120	450	35°	>80	3 000	25 000	GU10	Si	49 x 55	6
80476	5.5	60	127	550	35°	>80	2 700	25 000	GU10	Si	50 x 57	12
80480	6	60	100-240	525	35°	>80	2 700	25 000	GU10	No	54 x 50	12
80481	6	60	100-240	550	35°	>80	6 500	25 000	GU10	No	54 x 50	12

\* En sustitución de lámparas halógenas / Replacing halogen lamps.



# LED SUPERIOR PAR16 IRC90

Las lámparas PAR16 aseguran una iluminación profesional, debido a su alto IRC >90, ideal para boutiques, showrooms, galerías, museos, etc. donde se requiera una alta fidelidad de color.

The AR111 lamps ensure professional lighting, due to its high IRC (90%), ideal for boutiques, showrooms, galleries, museums, etc. where high color fidelity is required



**HASTA  
90%  
DE  
ECONOMÍA**

SAVES UP TO  
SAVINGS

**3**

AÑOS DE  
GARANTÍA

YEAR  
WARRANTY

**HASTA  
25 000h  
VIDA ÚTIL**

PRODUCT  
LIFE

**100 – 240 V~**

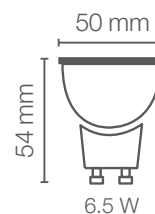

## APLICACIONES / APPLICATIONS

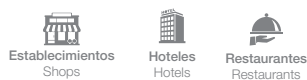

Código Sku	Potencia Power (W)	Equivalencia Equivalence Halógena (W)	Flujo Luminoso Luminous Flux (lm)	Ángulo de Apertura Opening Angle	IRC CRI	Temp. Color Color Temp. (K)	Vida Útil Life (h)	Base Base	Atenuable Dimmable	Dimensiones Dimensions (mm)	Unidades por Caja Units per box
80478	6.5	60	525	35°	>90	● 2 700	25 000	GU10	No	50 x 54	12
80479	6.5	60	550	35°	>90	● 6 500	25 000	GU10	No	50 x 54	12

\* En sustitución de lámparas halógenas / Replacing halogen lamps.



# LED PAR16 RGBW®

La familia LED RGBW es un sistema de iluminación controlado vía control remoto que cuenta con control de intensidad y cambio de colores, personaliza tus ambientes con un estilo único con control de atenuación.

LED RGBW REMOTE CONTROL products are a special illumination system controlled by infrared remote control with dimmable controls and change of some colors to personalize your spaces with an unique style with dimming control.



4.5W

**2**  
AÑOS DE GARANTÍA  
YEAR WARRANTY

HASTA **15 000h**  
VIDA ÚTIL  
PRODUCT LIFE

**100-240 V~**

**ATENUABLE**  
DIMMING

**COLOR RGBW**

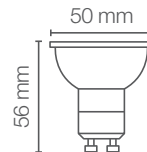

## APLICACIONES / APPLICATIONS

**Salas**  
Living rooms

**Recámaras**  
Rooms

**Áreas Gastronómicas**  
Gastronomic areas

**Hoteles**  
Hotels

**Restaurantes/Bares**  
Restaurants/Bars

Código Sku	Potencia Power (W)	Flujo Luminoso Luminous Flux (lm)	Ángulo de Apertura Opening Angle	IRC CRI	Temp. Color Color Temp. (K)	Vida Útil Life (h)	Base Base	Atenuable Dimmable	Dimensiones Dimensions (mm)	Unidades por Caja Units per box
88066	4.5	250	36°	>80	2 700 + RGBW	15 000	GU10	SI**	50 x 56	12

\* En sustitución de lámparas incandescentes / Replacing incandescent lamps.

\*\* Atenuable únicamente mediante control remoto (incluido) / Dimmable only by remote control (included).



# LED PAR16 VALUE

Las lámparas PAR16 VALUE garantizan una correcta iluminación de acento en objetos o elementos arquitectónicos. Disponibles en Luz Cálida (2 700 K) y Luz de Día (6 500 K).

PAR16 VALUE lamps ensure correct accent lighting on architectural objects or elements. Available in Warm Light (2 700 K) and Daylight (6 500 K).



PAR16

HASTA  
**90%**  
DE  
ECONOMÍA

SAVES UP TO  
SAVINGS

**3**  
AÑOS DE  
GARANTÍA

YEAR  
WARRANTY

HASTA  
**25 000h**  
VIDA ÚTIL

PRODUCT  
LIFE

**100-240 V~**

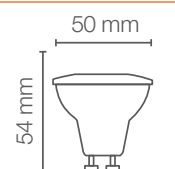

80474 y 80475

## APLICACIONES / APPLICATIONS

Ambientes  
residenciales  
Residential  
environments

Hoteles  
Hotels

Pasillos  
Corridors

Establecimientos  
Shops

Museos / Galerías  
Museums / Galleries

Código SKU	Potencia Power (W)	Equivalencia Equivalence Halógena (W)	Flujo Luminoso Luminous Flux (lm)	Ángulo de Apertura Opening Angle	IRC CRI	Temp. Color Color Temp. (K)	Vida Útil Life (h)	Base Base	Atenuable Dimmable	Dimensiones Dimensions (mm)	Unidades por Caja Units per box
80474	4	50	350	35°	>80	● 2 700	25 000	GU10	No	50 x 54	12
80475	4	50	370	35°	>80	● 6 500	25 000	GU10	No	50 x 54	12

\* En sustitución de lámparas halógenas / Replacing halogen lamps.





# LED PAR20 SUPERSTAR®

Las lámparas PAR20 SUPERSTAR en su versión atenuable, son ideales para denotar objetos y lugares en temperatura Luz Cálida (2 700 K) y Luz de Día (6 500 K).

PAR20 SUPERSTAR lamps in their dimmable version, are ideal for denoting objects and places in warm light temperature (2 700 K) and daylight (6 500 K).



PAR20

**HASTA  
90%  
DE  
ECONOMÍA**

SAVES UP TO  
SAVINGS

**3**

AÑOS DE  
GARANTÍA

YEAR  
WARRANTY

**HASTA  
25 000h  
VIDA ÚTIL**

PRODUCT  
LIFE

**120 V~**

85049

**127 V~**

85484

**ATENUABLE\***

DIMMING

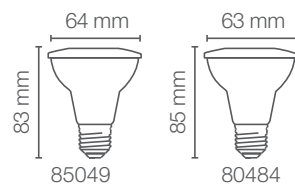

## APLICACIONES / APPLICATIONS

Ambientes  
residenciales  
Residential  
environments

Hoteles  
Hotels

Pasillos  
Corridors

Establecimientos  
Shops

Museos / Galerías  
Museums / Galleries

Código Sku	Potencia Power (W)	Equivalencia Equivalence Halógena (W)	Voltaje Voltage (V~)	Flujo Luminoso Luminous Flux (lm)	Ángulo de Apertura Opening Angle	IRC CRI	Temp. Color Color Temp. (K)	Vida Útil Life (h)	Base Base	Atenuable Dimmable	Dimensiones Dimensions (mm)	Unidades por Caja Units per box
85049	6	50	120	500	40°	>80	● 6 500	25 000	E27	Si	64 x 83	10
80484	6	50	127	525	25°	>80	● 2 700	25 000	E27	Si	63 x 85	12

\* En sustitución de lámparas halógenas / Replacing halogen lamps.



# LED PAR20 VALUE

Las lámparas PAR20 VALUE garantizan una correcta iluminación de acento en objetos o elementos arquitectónicos. Disponibles en Luz Cálida (2 700 K) y Luz de Día (6 500 K).

PAR20 VALUE lamps ensure correct accent lighting on architectural objects or elements. Available in Warm Light (2 700 K) and Daylight (6 500 K).



PAR20

**HASTA  
90%  
DE  
ECONOMÍA**

SAVES UP TO  
SAVINGS

**3**

AÑOS DE  
GARANTÍA

YEAR  
WARRANTY

**HASTA  
25 000h  
VIDA ÚTIL**

PRODUCT  
LIFE

**100-240 V~**

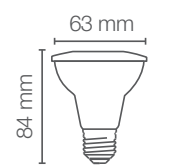

80482 y 80483

## APLICACIONES / APPLICATIONS



Código Sku	Potencia Power (W)	Equivalencia Equivalence Halógena (W)	Flujo Luminoso Luminous Flux (lm)	Ángulo de Apertura Opening Angle	IRC CRI	Temp. Color Color Temp. (K)	Vida Útil Life (h)	Base Base	Atenuable Dimmable	Dimensiones Dimensions (mm)	Unidades por Caja Units per box
80482	5.5	50	525	40°	>80	● 2 700	25 000	E27	No	63 x 84	12
80483	5.5	50	550	40°	>80	● 6 500	25 000	E27	No	63 x 84	12

\* En sustitución de lámparas halógenas / Replacing halogen lamps.



## LED PAR30 SUPERSTAR®

Las lámparas PAR30 SUPERSTAR atenuables son ideales para iluminación de acento en base E27, reemplaza a la tecnología de halógeno de 75 W.

The dimmable PAR30 SUPERSTAR lamps are ideal for accent lighting on E27 base, replace the 75 W halogen technology.



83156



83150 y 80486

SAVES UP TO SAVINGS	YEAR WARRANTY	PRODUCT LIFE	DIMMING	83156 83150	80486

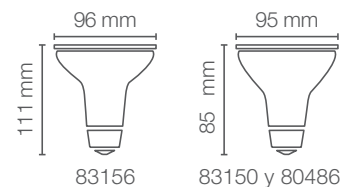

### APLICACIONES / APPLICATIONS

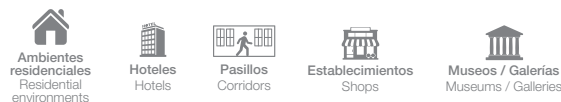

Código Sku	Potencia Power (W)	Equivalencia Equivalence Halógena (W)	Voltaje Voltage (V~)	Flujo Luminoso Luminous Flux (lm)	Ángulo de Apertura Opening Angle	IRC CRI	Temp. Color Color Temp. (K)	Vida Útil Life (h)	Base Base	Atenuable Dimmable	Dimensiones Dimensions (mm)	Unidades por Caja Units per box
83156	9	75	120	800	40°	>80	3 000	25 000	E27	Si	96 x 111	10
80486	9.5	75	127	900	25°	>80	2 700	25 000	E27	Si	95 x 85	12

\* En sustitución de lámparas halógenas / Replacing halogen lamps.





# LED PAR30 SUPERSTAR® IP65

Las lámparas PAR30 SUPERSTAR son ideales para iluminación de acento en exteriores, ya que cuentan con IP65, disponibles en Temperatura de color Cálida (2 700 K y 3 000 K) y Luz de Día (6 500 K).

PAR30 SUPERSTAR lamps are ideal for outdoor accent lighting as it has IP65, available in Warm color temperature (2 700 K and 3 000 K) and Daylight (6 500 K)



80492 / 80493

80490 / 80491

**HASTA  
80%  
DE  
ECONOMÍA**

SAVES UP TO  
SAVINGS

**3**

AÑOS DE  
GARANTÍA

YEAR  
WARRANTY

**HASTA  
25 000h  
VIDA ÚTIL**

PRODUCT  
LIFE

**IP65**

**100-240 V~**

85079

**100-277 V~**

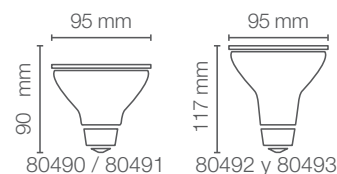

## APLICACIONES / APPLICATIONS



Código Sku	Potencia Power (W)	Equivalencia Equivalence Halógena (W)	Flujo Luminoso Luminous Flux (lm)	Ángulo de Apertura Opening Angle	IRC CRI	Temp. Color Color Temp. (K)	Vida Útil Life (h)	Base Base	Atenuable Dimmable	Dimensiones Dimensions (mm)	Unidades por Caja Units per box
85079	10		800	25°	>80	● 3 000	25 000	E27	No		10
80490	9.5	75	900	25°	>80	● 2 700	25 000	E27	No	95 x 90	12
80491	9.5	75	1000	25°	>80	● 6 500	25 000	E27	No	95 x 90	12
80492	9.5	75	900	25°	>80	● 2 700	25 000	E27	No	95 x 117	12
80493	9.5	75	1000	25°	>80	● 6 500	25 000	E27	No	95 x 117	12

\* En sustitución de lámparas halógenas / Replacing halogen lamps.





# LED PAR30 HCI SUPERSTAR®

Las lámparas LED PAR30 HCI SUPERSTAR son ideales para aplicaciones comerciales y profesionales, ya que cuentan con alto flujo luminoso de hasta 3100 lúmenes con opciones de IRC 80 e IRC 90 con base E27. Disponible en 15° y 30° en temperaturas de color desde 3000 K hasta 6500 K, sustituyendo lámparas de aditivos metálicos cerámicos HCI PAR30 de 70 W.

LED PAR30 HCI SUPERSTAR are perfect for commercial and professional applications due high luminous flux up to 3100lm with two options of CRI of 80 and 90 with E27 base. Available in 15° and 30° and color temperatures from 3000 K up to 6500 K, the perfect replacement for 70 W PAR30 HCI Halogen Lamps.



IRC 90



IRC 80

**HASTA 61% DE ECONOMÍA**  
SAVES UP TO SAVINGS

**3 AÑOS DE GARANTÍA**  
YEAR WARRANTY

**HASTA 15 000h VIDA ÚTIL**  
PRODUCT LIFE

**100 – 277 V~**

**3000K 4000K 6500K**

**ALTO FLUJO LUMINOSO**  
HIGH LUMINOUS FLOW

**LED COB**

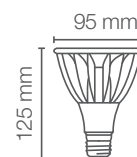

## APLICACIONES / APPLICATIONS

- Establecimientos Shops
- Hoteles Hotels
- Restaurantes Restaurants

Código Sku	Potencia Power (W)	Equivalencia Equivalence Halógena (W)	Flujo Luminoso Luminous Flux (lm)	Ángulo de Apertura Opening Angle	IRC CRI	Temp. Color Color Temp. (K)	Vida Útil Life (h)	Base Base	Atenuable Dimmable	Dimensiones Dimensions (mm)	Unidades por Caja Units per box
88133	29	75	3000	15	>80	● 3000	15000	E27	NO	95X125	12
88134	29	75	3000	15	>80	○ 4000	15000	E27	NO	95X125	12
88135	29	75	3000	15	>80	● 6500	15000	E27	NO	95X125	12
88136	29	75	3000	30	>80	● 3000	15000	E27	NO	95X125	12
88137	29	75	3000	30	>80	○ 4000	15000	E27	NO	95X125	12
88138	29	75	3000	30	>80	● 6500	15000	E27	NO	95X125	12
87958	37	75	3100	15	>90	● 3000	15000	E27	NO	95X125	12
87959	37	75	3100	15	>90	○ 4000	15000	E27	NO	95X125	12
87960	37	75	3100	30	>90	● 3000	15000	E27	NO	95X125	12
87961	37	75	3100	30	>90	○ 4000	15000	E27	NO	95X125	12

\* En sustitución de lámparas halógenas / Replacing halogen lamps.



# LED PAR30 VALUE

La familia LED Superstar PAR30 son ideales para usos comerciales ya que su acentuación direccional ofrece calidad de luz inigualable. Disponibles en temperatura: Luz Cálida (2 700 K) y Luz de Día (6 500 K).

LED PAR30 SUPERSTAR products are perfect for indoor and outdoor applications with an unique accent offering a magnificent quality. Available in Warm Light (2700 K) and Day Light (6500 K).



PAR30

HASTA  
**85%**  
DE  
ECONOMÍA

SAVES UP TO  
SAVINGS

**3**  
AÑOS DE  
GARANTÍA

YEAR  
WARRANTY

HASTA  
**25 000h**  
VIDA ÚTIL

PRODUCT  
LIFE

**100 – 240 V~**

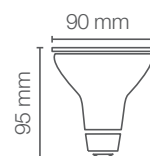

## APLICACIONES / APPLICATIONS

Ambientes  
residenciales  
Residential  
environments

Hoteles  
Hotels

Pasillos  
Corridors

Establecimientos  
Shops

Museos / Galerías  
Museums / Galleries

Código SKU	Potencia Power (W)	Equivalencia Equivalence Halógena (W)	Flujo Luminoso Luminous Flux (lm)	Ángulo de Apertura Opening Angle	IRC CRI	Temp. Color Color Temp. (K)	Vida Útil Life (h)	Base Base	Dimensiones Dimensions (mm)	Unidades por Caja Units per box
80488	9.5	75	900	25°	>80	● 2700	25 000	E27	90x95	12
80489	9.5	75	940	25°	>80	● 6500	25 000	E27	90x95	12

\* En sustitución de lámparas halógenas / Replacing halogen lamps.



# LED PAR38 SUPERSTAR® IP65

Las lámparas PAR38 SUPERSTAR son ideales para iluminación de acento en exteriores, ya que cuentan con IP65, disponibles en Temperatura de color Cálida (2 700 K y 3 000 K) y Luz de Día (6 500 K).

PAR38 SUPERSTAR lamps are ideal for outdoor accent lighting as it has IP65, available in Warm color temperature (2 700 K and 3 000 K) and Daylight (6 500 K)



80496 / 80497

**HASTA  
80%  
DE  
ECONOMÍA**

SAVES UP TO  
SAVINGS

**3**

AÑOS DE  
GARANTÍA

YEAR  
WARRANTY

**HASTA  
25 000h  
VIDA ÚTIL**

PRODUCT  
LIFE

**IP 65**

**100-277 V~**

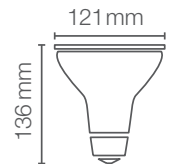

80496 y 80497

## APLICACIONES / APPLICATIONS

Ambientes  
residenciales  
Residential  
environments

Hoteles  
Hotels

Pasillos  
Corridors

Establecimientos  
Shops

Museos / Galerías  
Museums / Galleries

Jardines  
Gardens

Código Sku	Potencia Power (W)	Equivalencia Equivalence Halógena (W)	Flujo Luminoso Luminous Flux (lm)	Ángulo de Apertura Opening Angle	IRC CRI	Temp. Color Color Temp. (K)	Vida Útil Life (h)	Base Base	Atenuable Dimmable	Dimensiones Dimensions (mm)	Unidades por Caja Units per box
80496	13.5	90	1400	30°	>80	● 2 700	25 000	E27	No	136X121	12
80497	13.5	90	1600	30°	>80	● 6 500	25 000	E27	No	136X121	12

\* En sustitución de lámparas halógenas / Replacing halogen lamps.



# LED PAR38 VALUE

La familia LED Superstar PAR38 son ideales para usos comerciales ya que su acentuación direccional ofrece calidad de luz inigualable. Disponibles en temperatura: Luz Cálida (2 700 K) y Luz de Día (6 500 K).

LED PAR38 SUPERSTAR products are perfect for indoor and outdoor applications with an unique accent offering a magnificent quality. Available in Warm Light (2700 K) and Day Light (6500 K).



PAR38

**HASTA  
85%  
DE  
ECONOMÍA**

SAVES UP TO  
SAVINGS

**3**

AÑOS DE  
GARANTÍA

YEAR  
WARRANTY

**HASTA  
25 000h  
VIDA ÚTIL**

PRODUCT  
LIFE

**100 – 240 V~**

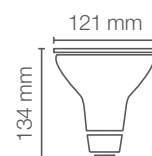

## APLICACIONES / APPLICATIONS

Ambientes  
residenciales  
Residential  
environments

Hoteles  
Hotels

Pasillos  
Corridors

Establecimientos  
Shops

Museos / Galerias  
Museums / Galleries

Código Skü	Potencia Power (W)	Equivalencia Equivalence Halógena (W)	Flujo Luminoso Luminous Flux (lm)	Ángulo de Apertura Opening Angle	IRC CRI	Temp. Color Color Temp. (K)	Vida Útil Life (h)	Base Base	Dimensiones Dimensions (mm)	Unidades por Caja Units per box
80494	13.5	90	1400	30°	>80	2700	25 000	E27	121X134	12
80495	13.5	90	1500	30°	>80	6500	25 000	E27	121X134	12

\* En sustitución de lámparas halógenas / Replacing halogen lamps.





---

# TUBOS LED



# LED T8 SUPERIOR

Las lámparas LED T8 SUPERIOR son ideales para aplicaciones comerciales y corporativas debido a su alto rango de voltaje (120-277 V~) y hasta 50,000 horas de vida. No necesita driver o balastro externo. Disponibles en 120cm y en todas las temperaturas de color. Material de vidrio.

LED T8 SUPERIOR products are perfect for commercial, industrial and corporate application due to wide voltage range (120-277 V~) and high hours life up to 50,000 hours. Does not need external ballast or driver. Available in 120 cm and all color temperatures. Glass material.



## APLICACIONES / APPLICATIONS



Código Sku	Potencia Power (W)	Equivalencia Equivalence Fluor. (W)	Flujo Luminoso Luminous Flux (lm)	IRC CRI	Temp. Color Color Temp. (K)	Vida Útil Life (h)	Acabado Product Finishing	Base Base	Dimensiones Dimensions (mm)	Unidades por Caja Units per box
80109	17	32 W	2200	>82	● 5000	50 000	OPALINO	G13	1 212 X 26	25
80110	17	32 W	2200	>82	● 3000	50 000	OPALINO	G13	1 212 X 26	25
80111	17	32 W	2200	>82	○ 4000	50 000	OPALINO	G13	1 212 X 26	25
80112	17	32 W	2200	>82	● 6500	50 000	OPALINO	G13	1 212 X 26	25

\* En sustitución de lámparas fluorescentes tubulares. / Replacing tubular fluorescent lamps.



# LED T8 SUPERSTAR®

Las lámparas LED T8 SUPERSTAR son ideales para aplicaciones comerciales y corporativas debido a su alto rango de voltaje (100-277 V~) y hasta 40,000 horas de vida. No necesita driver o balastro externo. Disponibles en 60cm y 120cm y en todas las temperaturas de color. Material de vidrio.

LED T8 SUPERSTAR products are perfect for industrial application due to wide voltage range (100-277 V~) and high hours life up to 40,000 hours. Does not need external ballast or driver. Available in 2ft and 4ft and all color temperatures. Glass material.



**HASTA  
50%  
DE  
ECONOMÍA**

SAVES UP TO  
SAVINGS

**3**

AÑOS DE  
GARANTÍA

YEAR  
WARRANTY

**HASTA  
40 000h  
VIDA ÚTIL**

PRODUCT  
LIFE

**100 – 277 V~**

**3000K  
4000K  
5000K  
6500K**

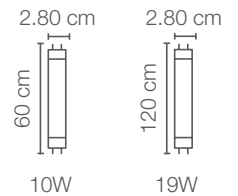

## APLICACIONES / APPLICATIONS



Código Sku	Potencia Power (W)	Equivalencia Equivalence Fluor. (W)	Flujo Luminoso Luminous Flux (lm)	IRC CRI	Temp. Color Color Temp. (K)	Vida Útil Life (h)	Acabado Product Finishing	Base Base	Dimensiones Dimensions (mm)	Unidades por Caja Units per box
80346	10	17	900	>80	● 3 000	40 000	OPALINO	G13	2.80 X60	25
80347	10	17	1000	>80	○ 4 000	40 000	OPALINO	G13	2.80 X60	25
80348	10	17	1000	>80	● 5 000	40 000	OPALINO	G13	2.80 X60	25
80349	10	17	1000	>80	● 6 500	40 000	OPALINO	G13	2.80 X60	25
80205	20	32	1800	>80	● 3 000	40 000	OPALINO	G13	2.80X120	25
80206	20	32	2000	>80	○ 4 000	40 000	OPALINO	G13	2.80X120	25
80352	19	32	2000	>80	● 5 000	40 000	OPALINO	G13	2.80X120	25
80353	19	32	2000	>80	● 6 500	40 000	OPALINO	G13	2.80X120	25

\* En sustitución de lámparas fluorescentes tubulares. / Replacing tubular fluorescent lamps.





# LED T8 SUPERSTAR® SENSOR

Las lámparas LED T8 SUPERSTAR SENSOR son ideales para aplicaciones comerciales y corporativas debido a su alto rango de voltaje (100-277 V~), cuenta con un sensor microondas de 5m y hasta 25,000 horas de vida. No necesita driver o balastro externo. Disponibles en 60cm y 120cm y en todas las temperaturas de color. Material de vidrio.

LED T8 SUPERSTAR SENSOR products are perfect for industrial application due to wide voltage range (100-277 V~), it has a 5m microwave sensor and high hours life up to 25,000 hours. Does not need external ballast or driver. Available in 2ft and 4ft and all color temperatures. Glass material.



HASTA  
50%  
DE  
ECONOMÍA

SAVES UP TO  
SAVINGS



3  
AÑOS DE  
GARANTÍA

YEAR  
WARRANTY



HASTA  
25 000h  
VIDA ÚTIL

PRODUCT  
LIFE



100 - 277 V~



3000K  
4000K  
5000K  
6500K

2.80 cm



60 cm

9W

2.80 cm



120 cm

18W

## APLICACIONES / APPLICATIONS



Código Sku	Potencia Power (W)	Equivalencia Equivalence Fluor. (W)	Flujo Luminoso Luminous Flux (lm)	IRC CRI	Temp. Color Color Temp. (K)	Vida Útil Life (h)	Acabado Product Finishing	Base Base	Dimensiones Dimensions (mm)	Unidades por Caja Units per box
80234	9	17	900	>80	3000	25 000	OPALINO	G13	600 X 28	25
80235	9	17	1000	>80	4000	25 000	OPALINO	G13	600 X 28	25
80236	9	17	1000	>80	6500	25 500	OPALINO	G13	600 X 28	25
80237	18	32	1850	>80	3000	25 000	OPALINO	G13	1 200 X 28	25
80238	18	32	2000	>80	4000	25 000	OPALINO	G13	1 200 X 28	25
80239	18	32	2000	>80	6500	25 500	OPALINO	G13	1 200 X 28	25

\* En sustitución de lámparas fluorescentes tubulares. / Replacing tubular fluorescent lamps.



# TUBO LED T8 VALUE® G2

Los tubos de LED T8 VALUE son una solución versátil para todo tipo de aplicaciones con bajo consumo de energía. No necesitan balastro.

LED T8 VALUE ideal for versatile lighting solutions, saving energy up to 50%. Does not need external ballast or driver.

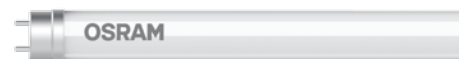

8W • 16W



16W Claro

**HASTA  
50%  
DE  
ECONOMÍA**

SAVES UP TO  
SAVINGS

**2**

AÑOS DE  
GARANTÍA

YEAR  
WARRANTY

**HASTA  
15 000h  
VIDA ÚTIL**

PRODUCT  
LIFE

**100 – 277 V~**

**3000K  
4000K  
5000K  
6500K**

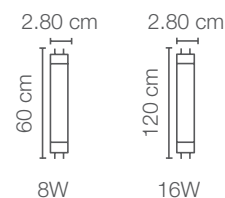

## APLICACIONES / APPLICATIONS



Código Sku	Potencia Power (W)	Equivalencia Equivalence Fluor. (W)	Flujo Luminoso Luminous Flux (lm)	IRC CRI	Temp. Color Color Temp. (K)	Vida Útil Life (h)	Acabado Product Finishing	Base Base	Dimensiones Dimensions (mm)	Unidades por Caja Units per box
85812	8	17	800	>80	3000	15 000	OPALINO	G13	2.80x60	25
85813	8	17	800	>80	4000	15 000	OPALINO	G13	2.80x60	25
85814	8	17	800	>80	5000	15 000	OPALINO	G13	2.80x60	25
85815	8	17	800	>80	6500	15 000	OPALINO	G13	2.80x60	25
85808	16	32	1 600	>80	3000	15 000	OPALINO	G13	2.80x120	25
85809	16	32	1 600	>80	4000	15 000	OPALINO	G13	2.80x120	25
85810	16	32	1 600	>80	5000	15 000	OPALINO	G13	2.80x120	25
85811	16	32	1 600	>80	6500	15 000	OPALINO	G13	2.80x120	25
85816	16	32	1 600	>80	4000	15 000	CLARO	G13	2.80x120	25
85817	16	32	1 600	>80	6500	15 000	CLARO	G13	2.80x120	25

\* En sustitución de lámparas fluorescentes tubulares. / Replacing tubular fluorescent lamps.



## TUBO LED T8 ECO®

Los tubos de LED T8 ECO son una solución para aquellas aplicaciones con iluminación práctica y funcional ya que no necesitan balastro.

LED T8 ECO ideal for functional lighting solutions. Does not need external ballast or driver.

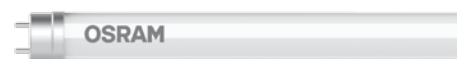

8W • 16W



16W Claro



SAVES UP TO SAVINGS



YEAR WARRANTY



PRODUCT LIFE



120 V~



4000K



8W

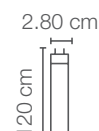

16W

### APLICACIONES / APPLICATIONS



Pasillos  
Corridors



Hoteles  
Hotels



Establecimientos  
Shops



Estacionamientos  
Parking lots

Código Sku	Potencia Power (W)	Equivalencia Equivalence Fluor. (W)	Flujo Luminoso Luminous Flux (lm)	IRC CRI	Temp. Color Color Temp. (K)	Vida Útil Life (h)	Acabado Product Finishing	Base Base	Dimensiones Dimensions (mm)	Unidades por Caja Units per box
80185	8	17	720	>80	3000	15 000	OPALINO	G13	2.80x60	25
80186	8	17	800	>80	4000	15 000	OPALINO	G13	2.80x60	25
80187	8	17	800	>80	5000	15 000	OPALINO	G13	2.80x60	25
80188	8	17	800	>80	6500	15 500	OPALINO	G13	2.80x60	25
80189	16	32	1440	>80	3000	15 000	OPALINO	G13	2.80x120	25
80190	16	32	1600	>80	4000	15 000	OPALINO	G13	2.80x120	25
80191	16	32	1600	>80	5000	15 000	OPALINO	G13	2.80x120	25
80192	16	32	1600	>80	6500	15 500	OPALINO	G13	2.80x120	25
80198	16	32	1600	>80	4000	15 000	CLARO	G13	2.80x120	25
80200	16	32	1600	>80	6500	15 500	CLARO	G13	2.80x120	25

\* En sustitución de lámparas fluorescentes tubulares. / Replacing tubular fluorescent lamps.





# LED T8 CURVALUM SUPERSTAR®

Las lámparas LED T8 CURVALUM SUPERSTAR ofrecen el reemplazo ideal de tubos fluorescentes de 32W, cuentan con driver integrado ahorrando energía de hasta 50%. Driver integrado. Disponible en temperatura Blanco Frío (4000 K) y Luz de Día (6500 K).

LED T8 CURVALUM SUPERSTAR are the ideal fluorescent tubes substitution, offering integrated driver and saving energy up to 50%. Available in Cool Light (4000 K) and Day Light (6500 K) temperature.



HASTA  
**50%**  
DE  
ECONOMÍA

SAVES UP TO  
SAVINGS

**3**  
AÑOS DE  
GARANTÍA

YEAR  
WARRANTY

HASTA  
**50 000h**  
VIDA ÚTIL

PRODUCT  
LIFE

**120 - 277 V~**

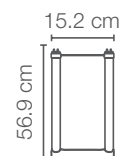

## APLICACIONES / APPLICATIONS



Código Sku	Potencia Power (W)	Equivalencia Fluor. (W)	Flujo Luminoso Luminous Flux (lm)	IRC CRI	Temp. Color Temp. (K)	Vida Útil Life (h)	Acabado Product Finishing	Base Base	Dimensiones Dimensions (mm)	Unidades por Caja Units per box
86341	18	32	2200	>80	○ 4000	50 000	OPALINO	G13	15.2X56.9	12
86342	18	32	2200	>80	● 6500	50 000	OPALINO	G13	15.2X56.9	12

\* En sustitución de lámparas fluorescentes tubulares. / Replacing tubular fluorescent lamps.





# LED T8 SLIM SUPERSTAR®

La lámpara LED T8 SLIM SUPERSTAR ofrece alto flujo luminoso, reemplazando T8 fluorescente Slimline de 59W. Driver integrado. Disponible en temperatura de Luz de Día (6500 K).

LED T8 SLIM SUPERSTAR offers high luminous flux, replacing T8 59W Slimline. Does not need external driver or ballast. Available at Day Light temperature (6500 K).



**HASTA  
50%  
DE  
ECONOMÍA**

SAVES UP TO  
SAVINGS

**3**

AÑOS DE  
GARANTÍA

YEAR  
WARRANTY

**HASTA  
30 000h  
VIDA ÚTIL**

PRODUCT  
LIFE

**100 - 277 V~**

**G13**

2.80 cm  
237.3 cm  
10W

## APLICACIONES / APPLICATIONS



Pasillos  
Corridors



Hangares  
Hangars



Estacionamientos  
Parking lots

Código Sku	Potencia Power (W)	Equivalencia Equivalence Fluor. (W)	Flujo Luminoso Luminous Flux (lm)	IRC CRI	Temp. Color Color Temp. (K)	Vida Útil Life (h)	Acabado Product Finishing	Base Base	Dimensiones Dimensions (mm)	Unidades por Caja Units per box
87900	36	60	3600	>80	● 6500	30 000	OPALINO	G13	2.8X237.3	8

\* En sustitución de lámparas fluorescentes tubulares. / Replacing tubular fluorescent lamps.



# LED T5 SUPERSTAR®

Las lámparas LED T5 SUPERSTAR cuentan con 5 años de garantía y 50,000 horas de vida, el sustituto ideal de tubos fluorescentes T5 de 14W, 28W y 54W ahorrando energía de hasta 50%. Cuentan con driver integrado. Hasta una eficacia de 150 lm/W.

LED T5 SUPERSTAR products offer 5 warranty years and 50,000 hours life and integrated driver. The ideal substitution of 14W, 28W and 54W T5 Fluorescent tubes, saving energy up to 50%. Efficacy up to 150 lm/W.

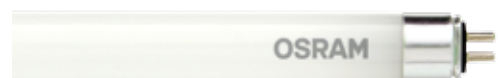

**HASTA 50% DE ECONOMÍA**

SAVES UP TO SAVINGS

**5 AÑOS DE GARANTÍA**

YEAR WARRANTY

**HASTA 50 000h VIDA ÚTIL**

PRODUCT LIFE

**100 - 277 V~**

**G5**

**3000K**

**4000K**

**5000K 6500K**

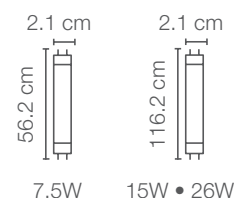

## APLICACIONES / APPLICATIONS



Código Sku	Potencia Power (W)	Equivalencia Equivalence Fluor. (W)	Flujo Luminoso Luminous Flux (lm)	IRC CRI	Temp. Color Color Temp. (K)	Vida Útil Life (h)	Acabado Product Finishing	Base Base	Dimensiones Dimensions (mm)	Unidades por Caja Units per box
87892	7.5	17	900	>80	● 3000	50 000	OPALINO	G5	21x 56.2	25
85828	7.5	17	900	>80	○ 4000	50 000	OPALINO	G5	21x 56.2	25
85829	7.5	17	900	>80	● 6500	50 500	OPALINO	G5	21x 56.2	25
85830	15	28	1850	>80	● 3000	50 000	OPALINO	G5	21x116.2	25
85831	15	28	1850	>80	○ 4000	50 000	OPALINO	G5	21x116.2	25
85832	15	28	1850	>80	● 5000	50 000	OPALINO	G5	21x116.2	25
85833	15	28	1850	>80	● 6500	50 500	OPALINO	G5	21x116.2	25
85834	26	54	3600	>80	● 3000	50 000	OPALINO	G5	21x116.2	25
85835	26	54	3900	>80	○ 4000	50 000	OPALINO	G5	21x116.2	25
85836	26	54	3900	>80	● 5000	50 000	OPALINO	G5	21x116.2	25
85837	26	54	3900	>80	● 6500	50 500	OPALINO	G5	21x116.2	25

\* En sustitución de lámparas fluorescentes tubulares. / Replacing tubular fluorescent lamps.





# ÍNDICE

## COMPONENTES ELECTRÓNICOS LEDVANCE

### TIRAS LED

---

TIRA LED ECO FLEX 12V	116
DRIVERS & ACCESORIOS ECO FLEX 12V	117
TIRA LED ECO KIT	118
TIRA LED ECO FLEX 127V IP65	119
TIRA LED ECO FLEX 127V IP44	120
TIRA LED PRIME FLEX 24V INTERIOR	121
TIRA LED PRIME FLEX 24V EXTERIOR	122
DRIVERS & ACCESORIOS ECO FLEX 24V	123
TIRA LED PERFORMANCE FLEX RGB	124
TIRA LED PERFORMANCE TUNABLE WHITE	125
DRIVERS & ACCESORIOS RGB & TW	126



### SENSORES

---

SENSORES INFRARROJO & MICROONDAS	127
SENSOR INDUSTRIAL IP65	
FOTOCELDA	128
DRIVERS DE EMERGENCIA	129







## TIRA LED ECO FLEX 12V

ECO FLEX 12V es una atractiva opción para iluminación en interiores y exteriores, que brinda la posibilidad de crear detalles finos y llamativos en hotelería, restaurantes y espacios arquitectónicos. ECO FLEX 12V cuenta con un diseño de alto desempeño y confiable que bajo sus estándares de calidad brindará una calidad en la reproducción de color y tono de luz ideales para proyectos.

ECO FLEX12V is an attractive solution for lighting indoor and outdoor that offer the possibility to create good details and striking in hotels, restaurants and architectural areas. ECO FLEX has a high-performance design and reliable that due their quality standard will offer a quality in color rendering and light tone ideal for projects.



### APLICACIONES / APPLICATIONS



Código Sku	Potencia/ m Power/m (W)	Flujo Luminoso Luminous Flux (lm/m)	Temp. Color Color Temp. (K)	Protección Protection	Vida Útil Life (h)	Uso Use	Dimensiones Dimensions (mm)	Unidades por Caja Units per box
86230	4.8	380	● 2700	IP20	20 000	Interior	5000 x 80 x 140	10
86231	4.8	400	○ 4000	IP20	20 000	Interior	5000 x 80 x 140	10
86232	4.8	400	● 6500	IP20	20 000	Interior	5000 x 80 x 140	10
86233	12	900	● 2700	IP20	20 000	Interior	5000 x 100 x 140	10
86235	12	950	○ 4000	IP20	20 000	Interior	5000 x 100 x 140	10
86236	12	950	● 6500	IP20	20 000	Interior	5000 x 100 x 140	10
86237	4.8	360	● 2700	IP65	20 000	Exterior	5025 x 1030 x 400	10
86238	4.8	380	○ 4000	IP65	20 000	Exterior	5025 x 1030 x 400	10
86239	4.8	380	● 6500	IP65	20 000	Exterior	5025 x 1030 x 400	10
86240	12	850	● 2700	IP65	20 000	Exterior	5025 x 1280 x 440	10
86241	12	900	○ 4000	IP65	20 000	Exterior	5025 x 1280 x 440	10
86242	12	900	● 6500	IP65	20 000	Exterior	5025 x 1280 x 440	10

# DRIVERS ECO FLEX 12V

La línea de Drivers ECO FLEX es un excelente aliado en el diseño de iluminación con tiras de LED de 12V, cuenta 4 modelos que harán más sencilla la instalación en interiores (IP20) y exteriores (IP65) en potencias de 30 y 60W. Las posibilidades en tus proyectos se complementan con el portafolio de accesorios de fácil conexión: I, L, T, X entre otros.

The range of LED Drivers Eco Flex is an excellent allied in the lighting design with LED strips 12V, it has 4 models that doing easier the installation in indoor (IP20 and outdoor (IP67) on wattages of 30W and 60W. the possibilities in your projects will be complete with portfolio of accessories of easy connection, same that no need any same that do not require any type of welding for installation with junction type connections: I, L, T, X among others.



Código Sku	Potencia Power (W)	Salida / Exit		Protección Protection	Uso Use	Ideal para tiras Ideal for strips	Dimensiones Dimensions (mm)	Unidades por Caja Units per box
		Tensión (V)	Corriente (A)					
86316	30	12	2.5	IP20	Interior	86230 / 86231 / 86232	1500 x 430 x 300	25
86317	60	12	5	IP20	Interior	86233 / 86235 / 86236	1820 x 430 x 300	18
86318	30	12	2.5	IP67	Exterior	86237 / 86238 / 86239	1460 x 400 x 290	15
86319	60	12	5	IP67	Exterior	86240 / 86241 / 86242	1600 x 420 x 310	15

## ACCESORIOS ECO FLEX 4.8W IP20 / ECO FLEX 4.8W IP20 ACCESSORIES

Código Sku	Descripción Description	Uso Use	Ideal para tiras Ideal for strips	Unidades por Caja Units per box
88855	CONECTOR I 8mm	Interior	Eco Flex 4.8W IP20	20
88857	CONECTOR L 8mm	Interior	Eco Flex 4.8W IP20	20
88859	CONECTOR T 8mm	Interior	Eco Flex 4.8W IP20	20
88861	CONECTOR X 8mm	Interior	Eco Flex 4.8W IP20	20

## ACCESORIOS ECO FLEX 12W IP20 / ECO FLEX 12W IP20 ACCESSORIES

Código Sku	Descripción Description	Uso Use	Ideal para tiras Ideal for strips	Unidades por Caja Units per box
88856	CONECTOR I 10mm	Interior	Eco Flex 12W IP20	20
88858	CONECTOR L 10mm	Interior	Eco Flex 12W IP20	20
88860	CONECTOR T 10mm	Interior	Eco Flex 12W IP20	20
88862	CONECTOR X 10mm	Interior	Eco Flex 12W IP20	20

## ACCESORIOS ECO FLEX 4.8W IP65 / ECO FLEX 4.8W IP65 ACCESSORIES

Código Sku	Descripción Description	Uso Use	Ideal para tiras Ideal for strips	Unidades por Caja Units per box
88863	PLUG DE SILICON 8mm	Exterior	ECO FLEX 4.8W IP65	20
83878	CONECTOR DE ENTRADA MACHO 8mm	Exterior	ECO FLEX 4.8W IP65	20
88869	TORNILLO PARA CINTA LED	Exterior	ECO FLEX 4.8W & 12W IP65	20
83877	GEL ADHESIVO DE SILICON	Exterior	ECO FLEX 4.8W & 12W IP65	20

## ACCESORIOS ECO FLEX 12W IP65 / ECO FLEX 12W IP65 ACCESSORIES

Código Sku	Descripción Description	Uso Use	Ideal para tiras Ideal for strips	Unidades por Caja Units per box
88864	PLUG DE SILICON 10mm	Exterior	ECO FLEX 12W IP65	20
88865	CONECTOR DE ENTRADA HEMBRA 10mm	Exterior	ECO FLEX 12W IP65	20



# TIRA LED ECO KIT

ECO KIT es una solución sencilla para pequeños espacios o lugares que demanden pequeños detalles de iluminación LED, este kit cuenta con una tira LED de 5 metros y un driver ya integrado que en conjunto con la cinta doble cara harán de éste producto la instalación mucho más rápida. Disponible en tonos de luz cálida, neutra y luz de día.

ECO KIT is a simple solution for small spaces or places that demand small details of LED lighting, this kit has a 5 meter LED strip and an integrated driver that together with the double-sided tape will make this product the installation much more fast Available in warm, neutral and daylight tones.



## APLICACIONES / APPLICATIONS



Código Sku	Potencia/ m Power/m (W)	Flujo Luminoso Luminous Flux (lm/m)	Temp. Color Color Temp. (K)	Protección Protection	Vida Útil Life (h)	Uso Use	Dimensiones Dimensions (mm)	Unidades por Caja Units per box
86243	4.8	380	● 2700	IP20	20 000	Interior	5000 x 80 x 140	10
86244	4.8	400	○ 4000	IP20	20 000	Interior	5000 x 80 x 140	10
86245	4.8	400	● 6500	IP20	20 000	Interior	5000 x 80 x 140	10





# TIRA LED ECO FLEX 127 V IP65

ECO FLEX 127V IP65 ofrece una opción adecuada para iluminación de exteriores con un excelente rendimiento de color, su tecnología permite integrar la tira a un sistema de control para la atenuación de la tira, sin necesidad de drivers adicionales para el correcto funcionamiento, además de poder instalarse hasta en tramos de 50 metros lineales con ayuda de sus accesorios.

ECO FLEX 127V IP65 offers suitable for outdoor lighting with excellent option of color rendering, their technology allows integrating the strip to a control system for dimming of strip without additional drivers for correct operation, besides it's able to be installed even in sections of 50 linear meters with the help of their accessories.



## APLICACIONES / APPLICATIONS

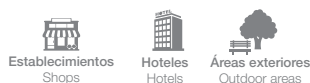

Código SKU	Potencia/ m Power/m (W)	Flujo Luminoso Luminous Flux (lm/m)	Temp. Color Color Temp. (K)	Protección Protection	Vida Útil Life (h)	Uso Use	Dimensiones Dimensions (mm)	Unidades por Caja Units per box
80017	9	550	● 2700	IP65	6 000	Exterior	25000 x 180 x 80	2
80018	9	550	○ 4000	IP65	6 000	Exterior	25000 x 180 x 80	2

## ACCESORIOS ECO FLEX IP65 / ECO FLEX IP65 ACCESSORIES

Código SKU	Descripción Description	Uso Use	Ideal para tiras Ideal for strips	Unidades por Caja Units per box
80125	Power cord 120V	Exterior	ECO FLEX 127V IP65	50
80127	Middle connector	Exterior	ECO FLEX 127V IP65	15
80128	Connect Pin	Exterior	ECO FLEX 127V IP65	150
80129	Clips	Exterior	ECO FLEX 127V IP65	100
80130	End cap	Exterior	ECO FLEX 127V IP65	50



# TIRA LED ECO FLEX 127 V IP44

ECO FLEX 127V IP44 es una nueva familia de productos que integran la perfecta solución en proyectos de iluminación de exterior para aplicaciones residenciales y de hotelería, esta línea de producto ofrece al usuario versiones de 5 y hasta 25 metros. Cuenta con 6 modelos entre los que destaca su versión de 2 200 K la cual excelente opción para crear atmósferas de mayor confort.

ECO FLEX 127V IP44 is a new family of products that integrate the perfect solution in outdoor lighting projects for residential and hotel applications, this product line offers the user versions of 5 and up to 25 meters. It has 6 models between which stands out its version of 2,200 K which excellent option to create atmospheres of greater comfort.

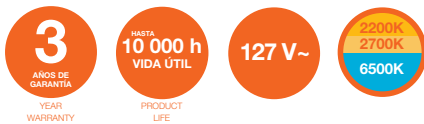

## APLICACIONES / APPLICATIONS

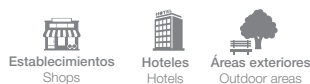

### 25m

Código Sku	Potencia/ m Power/m (W)	Flujo Luminoso Luminous Flux (lm/m)	Temp. Color Color Temp. (K)	Protección Protection	Vida Útil Life (h)	Uso Use	Dimensiones Dimensions (mm)	Unidades por Caja Units per box
88233	7	260	2 200	IP44	10 000	Exterior	25050 x 100 x 70	2
88218	7	300	2 700	IP44	10 000	Exterior	25050 x 100 x 70	2
88235	7	300	6 500	IP44	10 000	Exterior	25050 x 100 x 70	2

### 5m

88217	7	260	2 200	IP44	10 000	Exterior	5050 X 10 X 7	12
88232	7	300	2 700	IP44	10 000	Exterior	5050 X 10 X 7	12
88234	7	300	6 500	IP44	10 000	Exterior	5050 X 10 X 7	12

## ACCESORIOS ECO FLEX IP65 / ECO FLEX IP65 ACCESSORIES

Código Sku	Descripción Description	Uso Use	Ideal para tiras Ideal for strips	Unidades por Caja Units per box
80562	Connect Pin 2835	Exterior	ECO FLEX 127V IP44	250
80563	Power Cord 2835	Exterior	ECO FLEX 127V IP44	50
80564	End Cap 2835	Exterior	ECO FLEX 127V IP44	70
80565	Middle End 2835	Exterior	ECO FLEX 127V IP44	20
80566	Clip 2835	Exterior	ECO FLEX 127V IP44	120



# TIRA LED PRIME FLEX 24V IP20

La gama PRIME FLEX cuenta con las características adecuadas para el mercado de proyectos profesionales para interior que buscan soluciones de alto rendimiento y vida útil con el fin de brindar los mayores beneficios en sistemas de iluminación general en espacios comerciales y de oficinas.

The PRIME FLEX range has the right characteristics for the market of professional indoor projects that are looking for high performance and useful life solutions in order to provide the greatest benefits in general lighting systems in commercial and office spaces.



## APLICACIONES / APPLICATIONS



Código Sku	Potencia/ m Power/m (W)	Flujo Luminoso Luminous Flux (lm/m)	Temp. Color Color Temp. (K)	Protección Protection	Vida Útil Life (h)	Uso Use	Dimensiones Dimensions (mm)	Unidades por Caja Units per box
80001	9.6	1170	● 2700	IP20	50 000	Interior	5000 x 100 x 16	10
80002	9.6	1300	○ 4000	IP20	50 000	Interior	5000 x 100 x 16	10
80003	12	1500	● 2700	IP20	50 000	Interior	5000 x 100 x 16	10
80004	12	1650	○ 4000	IP20	50 000	Interior	5000 x 100 x 16	10
80005	16.8	2150	● 2700	IP20	50 000	Interior	5000 x 100 x 16	10
80006	16.8	2350	○ 4000	IP20	50 000	Interior	5000 x 100 x 16	10
80007	19.2	2400	● 2700	IP20	50 000	Interior	4553 x 100 x 16	10
80008	19.2	2600	○ 4000	IP20	50 000	Interior	4553 x 100 x 16	10





## TIRA LED PRIME FLEX 24V IP66

El segmento arquitectónico demanda soluciones para iluminación exterior que cubran las demandas de los nuevos diseños, PRIME FLEX 24V IP67 ofrece las máximas bondades y beneficios con sistemas que cuentan hasta con 2500 lm/m, una protección IP67 que evitará el amarillamiento de los equipos hasta por 5 años.

The architectural segment demands solutions for outdoor lighting that meet the demands of the new designs, PRIME FLEX 24V IP67 offers the maximum benefits with systems that have up to 2500 lm / m, an IP67 protection that will prevent yellowing of the equipment up to 5 years.

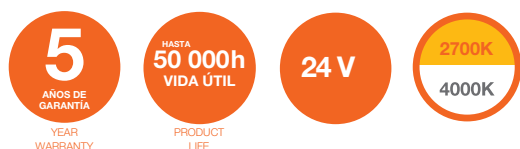

### APLICACIONES / APPLICATIONS



Código Sku	Potencia/ m Power/m (W)	Flujo Luminoso Luminous Flux (lm/m)	Temp. Color Color Temp. (K)	Protección Protection	Vida Útil Life (h)	Uso Use	Dimensiones Dimensions (mm)	Unidades por Caja Units per box
80009	9.6	1200	● 2700	IP66	50 000	Exterior	5030 X 125 X 48	10
80010	9.6	1100	○ 4000	IP66	50 000	Exterior	5030 X 125 X 48	10
80011	12	1350	● 2700	IP66	50 000	Exterior	5030 X 125 X 48	10
80012	12	1500	○ 4000	IP66	50 000	Exterior	5030 X 125 X 48	10
80013	16.8	1950	● 2700	IP66	50 000	Exterior	5030 X 125 X 48	10
80014	16.8	2150	○ 4000	IP66	50 000	Exterior	5030 X 125 X 48	10
80015	19.2	2200	● 2700	IP66	50 000	Exterior	4530 X 125 X 48	10
80016	19.2	2400	○ 4000	IP66	50 000	Exterior	4530 X 125 X 48	10

# DRIVERS ECO FLEX 24V

Amplíe sus posibilidades y alcances en proyectos con la línea de drivers PRIME FLEX, los cuales cuentan con modelos para interiores, exteriores y modelos atenuables para adaptarse a las necesidades de cada proyecto.

Expand your possibilities and reach in your projects with the PRIME FLEX Drivers range, these drivers have indoor, outdoor and dimmable models to adapt to the needs of each project.



Código Sku	Potencia Power (W)	Salida / Exit		Protección Protection	Uso Use	Ideal para tiras Ideal for strips	Atenuable Dimmable	Unidades por Caja Units per box
		Tensión (V)	Corriente (A)					
80039	100	100 - 277	4.1	IP20	Interior	80001 80002 80003 80004 80005 80006 80007 80008	No	20
80040	100	100 - 277	4.1	IP67	Interior	80009 80010 80011 80012 80013 80014 80015 80016	0- 10 V	10
80041	100	100 - 277	4.1	IP20	Exterior	80001 80002 80003 80004 80005 80006 80007 80008	No	20
80042	100	100 - 277	4.1	IP67	Exterior	80009 80010 80011 80012 80013 80014 80015 80016	0- 10 V	10

## ACCESORIOS ECO FLEX 4.8W IP20 / ECO FLEX 4.8W IP20 ACCESSORIES

Código Sku	Descripción Description	Unidades por Caja Units per box
80358	CONECTOR I 10mm 24V	20
80359	CONECTOR L 10mm 24V	20
80360	CONECTOR T 10mm 24V	20
80361	CONECTOR X 10mm 24V	20



# TIRA LED RGB

La nueva línea de tiras LED RGB de LEDVANCE complementa el porfolio de soluciones para iluminación arquitectónica. Ideales para el cambio de color específicos, generación de escenas y ambientes de acuerdo a tus necesidades en espacios tales como: plazas comerciales, fachadas, oficinas y salones de eventos.

The new LEDVANCE RGB LED strips range complements the porfolio of solutions for architectural lighting. Ideal for the specific color change, generation of scenes and settings according to your needs in spaces such as: commercial squares, facades, offices and event rooms.



## APLICACIONES / APPLICATIONS



Código Sku	Potencia/ m Power/m (W)	Flujo Luminoso Luminous Flux (lm/m)	Temp. Color Color Temp. (K)	Protección Protection	Vida Útil Life (h)	Uso Use	Dimensiones Dimensions (mm)	Unidades por Caja Units per box
88248	14.4	440	RGB	IP20	40 000	Interior	5000 x 80 x 14	10
88249	14.4	420	RGB	IP65	40 000	Exterior	5000 x 120 x 42	10





# TIRA LED TUNABLE WHITE

La nueva tira LED Tunable White cuenta con un sistema de dos diodos LED que le permite cambiar de temperatura de color desde los 2700 a los 6500K para logra ambientes adecuados para interiores y exteriores tales como: oficinas, salas de juntas, lobbies, restaurantes, escuelas y fachadas.

The new Tunable White LED strip has a system of two LED diodes that allows you to change its color temperature from 2700 to 6500K to achieve suitable indoor and outdoor environments such as: offices, boardrooms, lobbies, restaurants, schools and facades.

**4**  
AÑOS DE GARANTÍA  
YEAR WARRANTY

HASTA **40 000 h**  
VIDA ÚTIL  
PRODUCT LIFE

**24 V**  
PRODUCT LIFE

**5m**  
LONGITUD  
LENGTH

**2700 K - 6500 K**



## APLICACIONES / APPLICATIONS



Código Sku	Potencia/ m Power/m (W)	Flujo Luminoso Luminous Flux (lm/m)	Temp. Color Color Temp. (K)	Protección Protection	Vida Útil Life (h)	Uso Use	Dimensiones Dimensions (mm)	Unidades por Caja Units per box
88250	9.6	970	2 700 - 6 500 K	IP20	40 000	Interior	5000 x 80 x 14	10
88251	9.6	930	2 700 - 6 500 K	IP65	40 000	Exterior	5000 x 120 x 42	10

# DRIVERS Y ACCESORIOS RGB & TW



Código Sku	Potencia Power (W)	Salida / Exit		Protección Protection	Uso Use	Ideal para tiras Ideal for strips	Atenuable Dimmable	Dimensiones Dimensions (mm)	Unidades por Caja Units per box
		Tensión (V)	Corriente (A)						
88252	288	24	12	IP20	Interior	88248 88249	Si	970 x 330 x 180	10
88254	REMOTE CONTROL RGB RF							1080 x 580 x 80	10

## ACCESORIOS RGB / RGB ACCESSORIES

Código Sku	Descripción Description	Uso Use	Ideal para tiras Ideal for strips	Unidades por Caja Units per box
88257	CONNECTOR I RGB IP20 24V	Interior	RGB IP20	10
88259	CONNECTOR L RGB IP20 24V	Interior	RGB IP20	10
88261	CONNECTOR T RGB IP20 24V	Interior	RGB IP20	10
88263	CONNECTOR X RGB IP20 24V	Interior	RGB IP20	10
88256	END CAP RGB & TW IP65	Exterior	RGB IP65	10

# DRIVERS TUNABLE WHITE



Código Sku	Potencia Power (W)	Salida / Exit		Protección Protection	Uso Use	Ideal para tiras Ideal for strips	Atenuable Dimmable	Dimensiones Dimensions (mm)	Unidades por Caja Units per box
		Tensión (V)	Corriente (A)						
88253	120	24	5	IP20	Interior	88250 88251	Si	97 X 33 X 18	10
88255	REMOTE CONTROL TW RF							108 X 58 X 8	10

## ACCESORIOS TUNABLE / TUNABLE ACCESSORIES

Código Sku	Descripción Description	Uso Use	Ideal para tiras Ideal for strips	Unidades por Caja Units per box
88258	CONNECTOR I TW IP20 24V	Interior	Tunable White IP20	10
88260	CONNECTOR L TW IP20 24V	Interior	Tunable White IP20	10
88262	CONNECTOR T TW IP20 24V	Interior	Tunable White IP20	10
88264	CONNECTOR X TW IP20 24V	Interior	Tunable White IP20	10
88256	END CAP RGB & TW IP65	Exterior	Tunable White IP65	10



# SENSORES INFRARROJO & MICROONDAS

Los sensores de movimiento son una excelente opción en proyectos que buscan eficiencia y obtener los mayores ahorros de energía, la línea de sensores de LEDVANCE cuenta con una solución que integra tecnologías de microondas e infrarrojo con opciones para diferentes tipos de instalación.

Motion sensors are an excellent option in projects that are looking for efficient and obtain the greatest energy savings, the LEDVANCE sensor line has a solution that integrates microwave and infrared technologies with options for different installation type.



85196



85197



85198



85199



85200



85202



85203



80447

3 AÑOS DE GARANTÍA / YEAR WARRANTY
120-277 V~
IP20
IP44
IP65

## APLICACIONES / APPLICATIONS



Oficinas / Offices



Salas de juntas / Meeting rooms



Baños / Bathrooms



Salas / Living rooms



Estacionamientos / Parking lots

Código / Sku	Descripción / Description	Protección / Protection	Carga máxima LED/ Fluorescente(W) / Maximum LED load / Fluorescent(W) / 127/ 220 / 277	Carga máxima Halógena / Incandescente(W) / Maximum Halogen load / Incandescent(W) / 127/ 220 / 277
85196	LDV- MS- INF-C- 360- 120-277V-IP20-WH-A	IP20	200 / 300 /300 W	800 / 1 000 / 1 200 W
85197	LDV- MS- INF-C- 360- 120-277V-IP20-WH-B	IP20	200 / 300 /300 W	800 / 1 000 / 1 200 W
85198	LDV- MS- MIC-C- 360- 120-277V-IP20-WH-A	IP20	200 / 300 /300 W	800 / 1 000 / 1 200 W
85199	LDV- MS- MIC-C- 360- 120-277V-IP20-WH-B	IP20	200 / 300 /300 W	800 / 1 000 / 1 200 W
85200	LDV- MS- INF-W- 120- 120-277V-IP20-WH-A	IP20	200 / 300 /300 W	800 / 1 000 / 1 200 W
85202	LDV- MS- INF-W- 180- 120-277V-IP44-WH-A	IP44	200 / 300 /300 W	800 / 1 000 / 1 200 W
85203	LDV- MS- INF-W- 180- 120-277V-IP44-WH-B	IP44	200 / 300 /300 W	800 / 1 000 / 1 200 W

Código / Sku	Descripción / Description	Protección / Protection	Carga máxima LED/ Fluorescente(W) / Maximum LED load / Fluorescent(W) / 127/ 220 / 277	Carga máxima Halógena / Incandescente(W) / Maximum Halogen load / Incandescent(W) / 127/ 220 / 277
80447	LDV-MS-MIC-HB-360-120-277-IP65-BLK	IP65	500 / 1 000 / 1 000 W	1 000 / 2 000 / 2 000 W



Código Sku	Tecnología Technology	Montaje Mount	Protección Protection	Altura de Montaje Mounting Height (m)	Unidades por Caja Units per box
85196	Infrarrojo	Sobreponer	IP20	2.2 - 4 m	24
85197	Infrarrojo	Empotrar	IP20	2.2 - 4 m	50
85198	Microondas	Empotrar	IP20	2.2 - 4 m	50
85199	Microondas	Empotrar	IP20	1.5-3.5 m	50
85200	Infrarrojo	Empotrar	IP20	1 - 1.8 m	100
85202	Infrarrojo	Sobreponer	IP44	1.8-2.5 m	50
85203	Infrarrojo	Sobreponer	IP44	1.8-2.5 m	50

Código Sku	Tecnología Technology	Montaje Mount	Atenuación Dimming	Protección Protection	Altura de Montaje Mounting Height (m)	Unidades por Caja Units per box
80447	Microondas	Sobreponer	1-10 V	IP20	15 m	10

## ACCESORIOS DE MONTAJE / MOUNTING ACCESSORIES

Código Sku	Descripción Description	Unidades por Caja Units per box
80449	ACCESORIO DE MONTAJE PARA TECHO	10
80450	ACCESORIO DE MONTAJE TIPO BISAGRA	10

# FOTOCELDA

La necesidad de instalar un control de iluminación es una de las prioridades en la mayoría de las instalaciones tanto residencial, comercial, alumbrado público e industrial. La nueva fotocelda de LEDVANCE permite realizar un control automático de encendido y/o apagado de los sistemas de iluminación. Diseñada con altos estándares de calidad y desempeño para todas las aplicaciones.

The need to install lighting control is one of the priorities in most installations, both residential, commercial, public and industrial lighting. The new LEDVANCE photocell allows automatic control of the lighting systems on and off. Designed with high quality and performance standards for all applications.



Código Sku	Descripción Description	Carga máxima Maximum load	Tecnología Technology	Montaje Mounting	Protección Protection	Nivel de iluminación de ambiente Light ambient	Unidades por Caja Units per box
85204	LDV- PC-E- 120-277V-IP44-BLU	5A	Fotosensor	Sobreponer	IP44	<15 LUX	100



## DRIVERS DE EMERGENCIA

La línea de drivers de emergencia de LEVANCE es una excelente opción para sistemas LED que requieren ser operados en casos de cortes de energía o siniestros y brindar la seguridad adecuada a usuarios en las instalaciones de oficinas, hospitales, y lugares públicos.

The range of LEDVANCE emergency drivers is an excellent option for LED systems that need to be operated in cases of power outages or accidents and provide adequate security to users in hospital office facilities, and public places.

**5**  
AÑOS DE GARANTÍA DRIVER  
YEARS OF WARRANTY DRIVER

**3**  
AÑOS DE GARANTÍA BATERÍA  
YEARS OF WARRANTY BATTERY

**120-277 V~**

**90 min**  
RESPALDO MODO EMERGENCIA  
EMERGENCY MODE

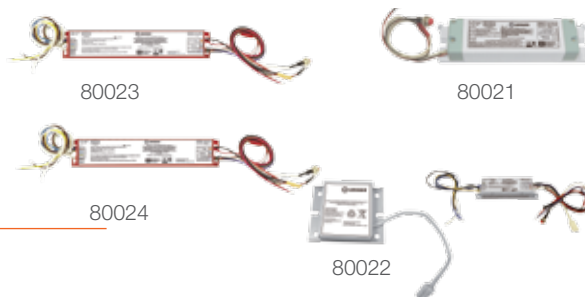

### APLICACIONES / APPLICATIONS



Código Sku	Descripción Description	Potencia Power (W)	Tensión de salida Output Voltage (V)	Corriente de salida Output Current (A)	Tipo de batería Battery type	Unidades por Caja Units per box
80021	LDV-EM-4W-CD60V-120-277V	4	10 - 60 V	50 - 500 mA	Ion-Litio	30
80024	LDV-EM-8W-CD55V-100-277V	8	15 - 52 V	240 - 480 mA	Nicquel-Cadmio	15
80023	LDV-EM-12W-CD55V-120-277V	12	15 - 52 V	200 - 750 mA	Nicquel-Cadmio	15
80022	LDV-EM-8W-CD52V-120-277V	8	15 - 55 V	130 - 540 mA	Ion-Litio	24

## ACERCA DE LEDVANCE

Con oficinas en más de 50 países y actividades comerciales en más de 140 países, LEDVANCE es uno de los principales proveedores de iluminación general del mundo para usuarios profesionales y consumidores finales. Tras emerger del negocio de iluminación general de OSRAM GmbH, LEDVANCE ofrece una amplia gama de luminarias LED para una gran variedad de usos en áreas de aplicación, productos de iluminación inteligente para hogares y edificios inteligentes, una de las carteras de lámparas LED más grandes de la industria, así como también fuentes de luz tradicionales.



# LEDVANCE

LEDVANCE S.A. DE C.V.  
Camino a Tapalapa No. 6  
Col. San Martín Tultitlán  
Tultitlán, Estado de México, México, CP 54900  
01 800 7 16 7000 (dentro de la República)  
5809 1807 (CDMX y Zona Metropolitana)

Síguenos en redes sociales @ledvancemexico



## LEDVANCE.LAT

Licencia de producto de marca OSRAM  
para lámparas en iluminación general

